

TADANO ROUGH TERRAIN CRANE
MODEL : GR-600EX

(Left-hand steering)

GENERAL DATA

<u>CRANE CAPACITY</u>		60,000 kg at 3.0 m
<u>BOOM</u>		5-section, 11.0 m — 43.0 m
<u>DIMENSION</u>		
Overall length	approx.	13,380 mm
Overall width	approx.	3,315 mm
Overall height	approx.	3,790 mm
<u>MASS</u>		
Gross vehicle mass	approx.	43,760 kg
-front axle	approx.	21,545 kg
-rear axle	approx.	22,215 kg
<u>PERFORMANCE</u>		
Max. traveling speed	computed	36 km/h
Gradeability (tan θ)	computed	147 % (at stall) *30 %

* Machine should be operated within the limit of engine crankcase design (17° : MITSUBISHI 6M60-TL).

CRANE SPECIFICATIONS

<u>MODEL</u>	GR-600EX
<u>CAPACITY</u>	60,000 kg at 3.0 m
<u>BOOM</u>	<p>Five section full power partially synchronized telescoping boom of round box construction with 5 sheaves at boom head. The synchronization system consists of 2 telescope cylinders, extension cables and retraction cables.</p> <p>Hydraulic cylinders fitted with holding valves.</p> <p style="padding-left: 40px;">Fully retracted length. 11.0 m</p> <p style="padding-left: 40px;">Fully extended length. 43.0 m</p> <p style="padding-left: 40px;">Extension speed. 32.0 m in 128 s</p>
<u>JIB</u>	<p>Two staged swingaround boom extension. Triple offset (3.5°/25°/45°) type. Stows alongside base boom section.</p> <p>Assistant cylinders for mounting and stowing.</p> <p>Single sheave at jib head.</p> <p style="padding-left: 40px;">Length. 10.1 m and 17.7 m</p>
<u>SINGLE TOP (AUXILIARY BOOM SHEAVE)</u>	<p>Single sheave.</p> <p>Mounted to main boom head for single line work.</p>
<u>ELEVATION</u>	<p>By a double-acting hydraulic cylinder, fitted with holding valve.</p> <p>Automatic speed reduction and soft stop function.</p> <p style="padding-left: 40px;">Boom angle -1.6° to 80.3°</p> <p style="padding-left: 40px;">Boom raising speed. 20° to 60° in 46 s</p>
<u>HOIST - Main winch</u>	<p>Variable speed type with grooved drum driven by hydraulic axial piston motor through winch speed reducer. Power load lowering and hoisting. Equipped with automatic brake (Neutral brake) and counterbalance valve. Controlled independently of auxiliary winch.</p> <p style="padding-left: 40px;">Single line pull. 54.9 kN {5,600 kgf}</p> <p style="padding-left: 40px;">Single line speed. 136 m/min (at the 4th layer)</p> <p style="padding-left: 40px;">Wire rope. Non-spin type</p> <p style="padding-left: 80px;">Diameter x length. 19 mm x 235 m</p>
<u>HOOK BLOCK(Optional) - 60 t capacity</u>	6 sheaves, swivel type hook with safety latch.
<u>HOOK BLOCK(Optional) - 35 t capacity</u>	3 sheaves, swivel type hook with safety latch.

HOIST -Auxiliary winch

Variable speed type with grooved drum driven by hydraulic axial piston motor through winch speed reducer. Power load lowering and hoisting. Equipped with automatic brake (Neutral brake) and counterbalance valve. Controlled independently of main winch.

Single line pull.	54.9 kN {5,600 kgf}
Single line speed.	136 m/min (at the 4th layer)
Wire rope.	Non-spin type
Diameter x length.	19 mm x 133 m

HOOK BLOCK -5.6 t capacity

Swivel hook with safety latch for single line use.

SWING

Hydraulic axial piston motor driven through planetary speed reducer. Continuous 360° full circle swing on ball bearing slew ring. Equipped with manually locked/released swing brake.

Swing speed.	2.4 min ⁻¹ {rpm}
----------------------	-----------------------------

HYDRAULIC SYSTEM

Pumps. 2 variable piston pumps for telescoping, elevating and winches.
Tandem gear pump for steering, swing and optional equipment.

Control valves. Multiple valves actuated by pilot pressure with integral pressure relief valves.

Circuit. Equipped with air cooled type oil cooler.
Oil pressure appears on AML display for main circuit.

Hydraulic oil tank capacity. . .
approx. 840 liters

Filters. Return line filter

CRANE CONTROL

By 4 control levers for swing, boom hoist, main winch, boom telescoping or auxiliary winch with 2 control pedals for boom hoist and boom telescoping based on ISO standard layout. Control lever stands can change neutral positions and tilt for easy access to cab.

CAB

Both crane and drive operations can be performed from one cab mounted on rotating superstructure. One sided one-man type, steel construction with sliding door access and tinted safety glass windows opening at side. Door window is powered control.
Operator's 3 way adjustable seat with headrest and armrest.
Hot water cab heater and air conditioning.

TADANO Automatic
Moment Limiter
(Model: AML-C)

Main unit in crane cab gives audible and visual warning of approach to overload. Automatically cuts out crane motions before overload. With working range (load radius and/or boom angle and/or tip height and/or swing range) limit function.

Automatic Speed Reduction and Soft Stop function on boom elevation and swing.

Following functions are displayed.

- Load as percentage
- Number of parts of line of rope
- Boom angle
- Boom length
- Load radius
- Outriggers position
- On-tire indicator
- Actual hook load
- Permissible load
- Boom position indicator
- Potential hook height
- Swing angle
- Main hydraulic oil pressure
- Jib length and jib offset angle (only when jib operation)

OUTRIGGERS

Hydraulically operated H-type outriggers. Each outrigger controlled simultaneously or independently from the cab.

Equipped with sight level gauge. Floats mounted integrally with the jacks retract to within vehicle width.

All cylinders fitted with pilot check valves.

Crane operation with different extended length of each outrigger.

Equipped with extension width detector for each outrigger.

Extended width	
Fully.	7,300 mm
Middle.	6,700 mm
Middle.	5,500 mm
Minimum.	2,700 mm
Float size (Diameter).	600 mm

COUNTERWEIGHT

Integral with swing frame (containing weight with auxiliary winch and wirerope)

Mass. 5,670 kg

NOTE : Each crane motion speed is based on unladen conditions.

CARRIER SPECIFICATIONS

<u>TYPE</u>	Rear engine, left-hand steering, driving axle 2-way selected type (by manual switch). 4 x 2 front drive 4 x 4 front and rear drive
<u>FRAME</u>	High-tensile steel, all welded mono-box construction.
<u>ENGINE</u>	Model. . . . MITSUBISHI 6M60-TL Type. . . . 4 cycle, turbo charged and after cooled, 6 cylinder in line, direct injection, water cooled diesel engine. Piston displacement. . . . 7,545 cm ³ Bore x stroke. 118 mm x 115 mm Max. output. 200 kW at 2,600 min ⁻¹ {rpm} Max. torque. 785 N·m at 1,400 min ⁻¹ {rpm}
<u>TRANSMISSION</u>	Electronically controlled full automatic transmission. Torque converter driving full powershift with driving axle selector. 6 forward and 2 reverse speeds. 3 speeds - High range - 2 wheel drive ; 4 wheel drive 3 speeds - Low range - 4 wheel drive
<u>AXLES</u>	Front. . . . Full floating type, steering and driving axle with planetary reduction. Rear. . . . Full floating type, steering and driving axle with planetary reduction. Non-spin differential.
<u>STEERING</u>	Hydraulic power steering controlled by steering wheel. Four steering modes available: 2-wheel front 2-wheel rear 4-wheel coordinated 4-wheel crab
<u>SUSPENSION</u>	Front. . . . Rigid mounted to the frame. Rear. . . . Pivot mounted with hydraulic lockout cylinders.
<u>BRAKE SYSTEM</u>	Service. . . Air over hydraulic disc brakes on all 4 wheels. Parking / Emergency. . . Spring applied-air released brake acting on input shaft of front axle. Auxiliary. . . Electro-pneumatic operated exhaust brake.
<u>ELECTRIC SYSTEM</u>	24 V DC. 2 batteries of 12 V - 120 Ah capacity.
<u>FUEL TANK CAPACITY</u>	300 liters
<u>TIRES</u>	Front.....29.5–25 22PR(OR) , Single x 2 Air pressure:350kPa or 29.5–25 28PR(OR) , Single x 2 Air pressure:330kPa Rear.....29.5–25 22PR(OR), Single x 2 Air pressure:350kPa or 29.5–25 28PR(OR), Single x 2 Air pressure:330kPa
<u>TURN RADIUS</u>	Min. turning radius (at center of extreme outer tire) 2-wheel steering. 11.9 m 4-wheel steering. 6.8 m

EQUIPMENT

STANDARD EQUIPMENT

Pendant type over-winding cutout
 External lamp (AML)
 Winch drum mirror
 Swing lock
 Winch automatic fail-safe brake
 Winch drum rotation indicator (Audible and Visual type)
 Over-unwinding prevention
 Cable follower
 Hook safety latch
 Pilot check valves
 Holding valves
 Counterbalance valves
 Hydraulic pressure relief valves
 Swing brake
 Positive control
 Hydraulic oil thermometer
 Hydraulic oil cooler
 Hot water cab heater, air conditioner and defroster
 Electric windshield wiper and washer
 Roof window wiper and washer
 Power window (Cab door)
 Tachometer/Speedometer
 3 way adjustable cloth seat with seat belt, headrest and armrest
 Cab floor mat
 Sun visor (Front and roof)
 Tilt-telescope steering wheel
 Boom elevation foot pedal
 Boom telescoping foot pedal
 Parking braked travel warning
 Automatic moment limiter (AML)
 Boom angle indicator
 Outrigger extension width detector
 Sight level gauge
 Automatic drive system
 Transmission neutral position engine start
 Overshift prevention
 Back-up alarm
 Air cleaner dust indicator
 Air dryer
 Water separator with filter
 Hydraulic lockout suspension
 Non-spin differential (Rear)
 Towing eyes - front and rear
 Outrigger control box(Both side of carrier)
 Engine over-run alarm
 Emergency engine stop system
 Telematics (machine data logging and monitoring system)
 with HELLO-NET via internet (availability depends on countries).
 Fuel consumption monitor
 Eco mode system
 Beacon lamp

OPTIONAL EQUIPMENT

Anemometer
 Radiator cover
 Tire inflation kit
 Air heater (Diesel fuel type)
 Engine coolant heater (Diesel fuel type)
 Fuel filter heater

Hook block - 60t capacity (6 sheaves, swivel type with safety latch.
 Mass : approx. 550 kg)
 Hook block -35t capacity (3 sheaves, swivel type with safety latch.
 Mass : 460 kg)

RATED LIFTING CAPACITIES ISO 4305

ON OUTRIGGERS FULLY EXTENDED 7.3m SPREAD																				
360° ROTATION (Unit: x 1,000kg)																				
B	A	11.0m		15.0m		19.0m			27.0m			35.0m			39.0m		43.0m			
	C	C	C	C	C	C	C	C	C	C	C	C	C	C	C	C	C			
3.0	68	60.0	74	40.8	78	32.0	78	22.0												
3.5	65	54.9	72	40.8	76	32.0	76	22.0												
4.0	62	53.8	70	40.8	75	32.0	75	22.0												
4.5	59	47.7	68	40.8	73	32.0	73	22.0	78	22.0	78	17.0								
5.0	56	42.8	66	40.8	72	32.0	72	22.0	77	21.3	77	17.0								
5.5	52	38.7	64	37.5	70	32.0	70	22.0	76	20.3	76	17.0								
6.0	48	35.3	61	34.6	68	31.9	68	22.0	75	19.4	75	17.0								
6.5	44	32.4	59	32.0	67	30.3	67	22.0	74	18.6	74	16.2	79	14.0	79	12.0				
7.0	39	29.9	57	29.6	65	28.8	65	22.0	73	17.8	73	15.6	78	13.5	78	11.7				
7.5	34	27.7	54	27.4	64	25.8	63	22.0	72	17.7	72	14.9	77	13.0	77	11.3				
8.0	28	25.7	52	24.9	62	23.2	61	22.0	71	17.6	71	14.4	76	12.6	76	10.9	78	10.0		
8.5	20	22.6	49	22.0	60	21.0	60	22.0	70	17.5	70	13.9	75	12.2	76	10.5	77	10.0		
9.0			47	19.5	58	19.1	58	21.7	68	17.4	69	13.4	75	11.9	75	10.2	76	10.0	80	9.0
10.0			40	15.8	54	15.3	54	17.8	66	15.7	66	12.4	73	11.8	73	9.5	75	9.6	78	8.7
11.0			34	13.0	50	12.6	50	15.0	64	13.6	64	11.5	71	11.6	71	8.9	73	9.1	77	8.3
12.0			25	10.9	46	10.5	46	12.8	62	11.6	62	10.6	69	11.4	70	8.5	72	8.6	75	7.9
14.0					36	7.6	36	9.7	56	8.6	56	9.3	66	9.1	66	7.7	69	7.9	72	7.4
16.0					22	5.5	21	7.5	51	6.5	51	7.9	62	7.0	62	6.7	66	7.4	71	7.3
18.0									45	5.0	45	6.4	58	5.5	58	5.9	62	6.1	66	5.7
20.0									39	3.9	38	5.2	54	4.4	54	5.2	59	4.9	63	4.6
22.0									30	3.1	29	4.3	50	3.5	50	4.5	55	4.1	60	3.7
24.0									17	2.4	17	3.6	45	2.8	46	3.7	51	3.3	56	3.0
26.0													40	2.2	40	3.2	47	2.8	53	2.4
28.0													34	1.7	34	2.7	43	2.3	49	1.9
30.0													27	1.3	27	2.3	38	1.9	45	1.5
32.0													16	1.0	16	1.9	32	1.5	41	1.2
34.0																	25	1.2	36	0.9
36.0																	14	1.0		
D	0																		27	
Telescoping conditions (%)																				
Telescoping mode	I, II	I	I	II	I	II	I	II	I	II	I	II	I	II	I	II	I, II	I, II	I, II	
2nd boom	0	50	100	0	100	0	100	0	100	0	100	0	100	0	50	100	100	100	100	
3rd boom	0	0	0	33	33	66	66	100	100	100	100	100	100	100	100	100	100	100	100	
4th boom	0	0	0	33	33	66	66	100	100	100	100	100	100	100	100	100	100	100	100	
Top boom	0	0	0	33	33	66	66	100	100	100	100	100	100	100	100	100	100	100	100	

LIFTING CAPACITIES AT ZERO DEGREE BOOM ANGLE ON OUTRIGGERS FULLY EXTENDED																			
7.3m SPREAD 360° ROTATION																			
C	A	11.0m		15.0m		19.0m			27.0m			35.0m			39.0m		43.0m		
	B	B	B	B	B	B	B	B	B	B	B	B	B	B	B	B	B	B	
0°	8.8	13.6	12.9	7.5	16.9	4.8	16.8	6.2	24.9	2.1	24.6	3.4	32.9	0.9	32.7	1.7	36.3	0.8	
Telescoping mode	I, II	I	I	II	I	II	I	II	I	II	I	II	I	II	I	II	I, II	I, II	I, II

- A : Boom length(m)
- B : Load radius(m)
- C : Loaded boom angle (°)
- D : Minimum boom angle (°) for indicated length (no load)

RATED LIFTING CAPACITIES

ISO 4305

ON OUTRIGGERS FULLY EXTENDED 7.3m SPREAD													
360° ROTATION													
C	43.0m Boom + 10.1m Jib						C	43.0m Boom + 17.7m Jib					
	3.5° Tilt		25° Tilt		45° Tilt			3.5° Tilt		25° Tilt		45° Tilt	
	R	W	R	W	R	W		R	W	R	W	R	W
80	10.1	4.2	13.4	3.5	15.7	2.9	80	11.6	2.6	17.5	2.1	21.7	1.7
79	11.0	4.2	14.4	3.3	16.6	2.9	79	12.9	2.6	18.5	2.0	22.6	1.7
78	12.2	4.2	15.2	3.2	17.5	2.8	78	13.9	2.6	19.8	2.0	23.6	1.6
77	13.1	4.1	16.3	3.1	18.3	2.7	77	15.0	2.6	20.6	1.9	24.5	1.6
76	14.0	3.9	17.1	3.0	19.2	2.7	76	16.2	2.5	21.7	1.9	25.4	1.6
75	14.9	3.8	18.1	3.0	20.1	2.6	75	17.3	2.4	22.8	1.8	26.3	1.5
73	16.8	3.5	20.0	2.8	21.7	2.5	73	19.4	2.3	24.7	1.7	28.0	1.5
70	19.5	3.2	22.6	2.6	24.1	2.3	70	22.7	2.1	27.7	1.6	30.5	1.4
68	21.3	3.0	24.2	2.5	25.7	2.3	68	24.5	2.0	29.4	1.5	32.0	1.3
65	23.9	2.8	26.6	2.3	27.9	2.2	65	27.6	1.8	32.2	1.4	34.4	1.3
63	25.5	2.7	28.2	2.3	29.4	2.1	63	29.3	1.7	33.8	1.4	35.8	1.2
60	27.8	2.2	30.3	1.9	31.3	1.8	60	32.2	1.4	36.4	1.2	37.9	1.0
58	29.3	1.9	31.6	1.6	32.6	1.5	58	33.8	1.2	37.7	0.9		
55	31.2	1.4	33.6	1.3	34.4	1.2							
53	32.6	1.2	34.9	1.1	35.5	1.0							
50	34.5	0.9											

ON OUTRIGGERS FULLY EXTENDED 7.3m SPREAD													
360° ROTATION													
C	39.0m Boom(telescoping mode II) + 10.1m Jib						C	39.0m Boom(telescoping mode II) + 17.7m Jib					
	3.5° Tilt		25° Tilt		45° Tilt			3.5° Tilt		25° Tilt		45° Tilt	
	R	W	R	W	R	W		R	W	R	W	R	W
80	9.5	4.6	13.1	3.8	15.5	3.2	80	10.9	2.8	17.2	2.3	21.1	1.8
79	10.5	4.6	13.9	3.6	16.2	3.1	79	12.0	2.8	18.2	2.2	21.9	1.8
78	11.4	4.6	14.8	3.5	17.1	3.0	78	13.1	2.8	19.0	2.1	22.8	1.7
77	12.5	4.5	15.8	3.4	17.9	2.9	77	14.4	2.8	20.0	2.1	23.7	1.7
76	13.3	4.4	16.6	3.3	18.6	2.9	76	15.3	2.7	20.9	2.0	24.4	1.7
75	14.2	4.2	17.4	3.2	19.5	2.8	75	16.4	2.7	21.9	1.9	25.4	1.6
73	15.9	3.9	19.1	3.1	21.0	2.7	73	18.3	2.5	23.7	1.8	26.9	1.6
70	18.4	3.6	21.5	2.8	23.2	2.5	70	21.3	2.3	26.3	1.7	29.2	1.5
68	20.1	3.4	23.0	2.7	24.7	2.4	68	23.1	2.2	28.1	1.6	30.7	1.4
65	22.5	3.1	25.3	2.6	26.5	2.3	65	26.0	2.0	30.7	1.5	32.9	1.4
63	24.0	3.0	26.7	2.5	27.9	2.3	63	27.8	1.9	32.4	1.5	34.4	1.3
60	26.3	2.8	28.6	2.3	29.6	2.2	60	30.1	1.8	34.4	1.4	36.3	1.3
58	27.8	2.7	30.2	2.3	31.1	2.1	58	32.1	1.7	36.2	1.4	37.6	1.3
55	29.8	2.3	32.0	2.0	32.8	1.9	55	34.4	1.5	38.3	1.3	39.7	1.2
53	31.0	2.0	33.1	1.8	33.8	1.7	53	35.8	1.3	39.6	1.1	40.6	1.0
50	32.8	1.7	34.8	1.5	35.3	1.5	50	37.9	1.1	41.4	0.9		
48	33.9	1.5	35.8	1.4	36.2	1.3	48	39.2	0.9				
45	35.6	1.2	37.0	1.1	37.6	1.1							
43	36.7	1.1	38.2	1.0									
40	38.1	0.9											

ON OUTRIGGERS FULLY EXTENDED 7.3m SPREAD													
360° ROTATION													
C	35m Boom(telescoping mode I) + 10.1m Jib						C	35m Boom(telescoping mode I) + 17.7m Jib					
	3.5° Tilt		25° Tilt		45° Tilt			3.5° Tilt		25° Tilt		45° Tilt	
	R	W	R	W	R	W		R	W	R	W	R	W
80	8.1	5.6	11.7	4.5	14.0	3.7	80	9.6	3.2	15.8	2.6	20.1	2.1
79	9.1	5.6	12.4	4.4	14.7	3.6	79	10.5	3.2	16.7	2.6	20.8	1.9
78	9.9	5.6	13.2	4.3	15.3	3.6	78	11.5	3.2	17.6	2.5	21.6	1.9
77	10.7	5.6	14.0	4.2	16.1	3.5	77	12.5	3.2	18.3	2.4	22.4	1.9
76	11.5	5.5	14.8	4.0	16.8	3.4	76	13.5	3.2	19.4	2.4	23.2	1.9
75	12.4	5.3	15.5	3.9	17.5	3.4	75	14.4	3.2	20.1	2.3	24.0	1.9
73	13.9	5.0	16.9	3.7	18.9	3.2	73	16.3	3.1	21.9	2.2	25.5	1.9
70	16.2	4.6	19.1	3.5	20.8	3.1	70	19.0	2.9	24.5	2.1	27.7	1.8
68	17.8	4.3	20.6	3.4	22.1	3.0	68	20.7	2.7	26.0	2.0	29.1	1.7
65	19.9	4.0	22.6	3.2	24.0	2.9	65	23.2	2.5	28.3	1.9	31.1	1.7
63	21.3	3.8	24.0	3.1	25.2	2.8	63	24.9	2.4	29.8	1.8	32.3	1.6
60	23.4	3.6	25.8	2.9	26.9	2.7	60	27.3	2.2	31.8	1.7	34.2	1.6
58	24.6	3.2	27.8	2.8	28.1	2.6	58	28.9	2.1	33.3	1.7	35.4	1.5
55	26.4	2.6	28.7	2.3	29.6	2.2	55	30.9	1.8	35.1	1.5	37.0	1.3
53	27.5	2.3	29.7	2.1	30.5	1.9	53	32.5	1.5	36.4	1.3	38.0	1.2
50	29.3	1.9	31.4	1.7	32.0	1.6	50	34.7	1.2	38.2	1.0	39.5	0.9
48	30.4	1.7	32.3	1.5	32.8	1.5	48	36.0	1.0	39.2	0.9		
45	32.0	1.4	33.7	1.3	34.1	1.2							
43	33.0	1.2	34.6	1.1									
40	34.5	1.0	35.9	0.9									
38	35.3	0.9											

C :boom angle (°)
R :Load radius(m)
W :Rated lifting capacity(Unit: × 1,000kg)

RATED LIFTING CAPACITIES ISO 4305

ON OUTRIGGERS MID EXTENDED 6.7m SPREAD																				
360° ROTATION (Unit: x 1,000kg)																				
B \ A	11.0m		15.0m		19.0m				27.0m				35.0m				39.0m		43.0m	
	C	C	C	C	C	C	C	C	C	C	C	C	C	C	C	C	C	C	C	
3.0	68	59.6	75	40.8	78	32.0	78	22.0												
3.5	65	53.3	72	40.8	76	32.0	76	22.0												
4.0	62	48.0	70	40.8	75	32.0	75	22.0												
4.5	59	43.5	68	40.8	73	32.0	73	22.0	78	22.0	79	17.0								
5.0	56	39.7	66	39.5	71	32.0	71	22.0	77	21.3	77	17.0								
5.5	52	36.4	64	36.2	70	32.0	70	22.0	76	20.3	77	17.0								
6.0	48	33.5	62	33.3	68	31.8	68	22.0	75	19.4	75	17.0								
6.5	44	31.0	59	30.8	67	27.9	66	22.0	74	18.6	74	16.2	79	14.0	79	12.0				
7.0	40	28.8	57	27.4	65	24.8	65	22.0	73	17.8	73	15.6	78	13.5	78	11.7				
7.5	34	25.5	54	24.4	63	22.2	63	22.0	72	17.7	72	14.9	78	13.0	77	11.3				
8.0	28	22.3	52	21.6	61	20.0	61	22.0	71	17.6	71	14.4	76	12.6	77	10.9	78	10.0		
8.5	20	19.7	49	19.0	59	18.1	60	20.9	70	17.4	70	13.9	75	12.2	76	10.5	77	10.0		
9.0			47	17.0	58	16.5	58	19.1	68	16.0	69	13.4	74	11.9	75	10.2	76	10.0	79	9.0
10.0			41	13.7	54	13.3	54	15.7	66	13.7	66	12.4	73	11.8	73	9.5	75	9.6	78	8.7
11.0			34	11.3	50	11.0	50	13.2	64	11.9	64	11.5	71	11.5	71	8.9	74	9.1	76	8.3
12.0			25	9.4	45	9.1	46	11.3	62	10.2	62	10.6	69	10.1	70	8.5	72	8.6	75	7.9
14.0					38	6.5	36	8.6	56	7.5	57	8.9	66	8.0	66	7.7	69	7.9	72	7.4
16.0					21	4.7	21	6.7	51	5.7	51	7.0	62	6.2	63	6.7	66	6.8	69	6.4
18.0									45	4.4	45	5.7	58	4.8	59	5.8	62	5.4	66	5.1
20.0									38	3.4	38	4.6	54	3.8	54	4.8	59	4.4	63	4.0
22.0									30	2.6	29	3.8	49	3.0	50	3.9	55	3.6	59	3.2
24.0									17	1.9	16	3.2	44	2.4	45	3.3	51	2.9	56	2.6
26.0													40	1.8	40	2.8	47	2.4	52	2.0
28.0													34	1.4	34	2.3	42	1.9	48	1.6
30.0													27	1.0	27	1.9	37	1.5	44	1.2
32.0															17	1.6	32	1.2	40	0.9
34.0																	25	0.9		
D	0																		30	
Telescoping conditions (%)																				
Telescoping mode	I, II	I	I	II	I	II	I	II	I	II	II	I, II								
2nd boom	0	50	100	0	100	0	100	0	100	0	100	0	50	100						
3rd boom	0	0	0	33	33	66	66	100	100	100										
4th boom	0	0	0	33	33	66	66	100	100	100										
Top boom	0	0	0	33	33	66	66	100	100	100										

LIFTING CAPACITIES AT ZERO DEGREE BOOM ANGLE ON OUTRIGGERS MID EXTENDED																				
6.7m SPREAD 360° ROTATION																				
C \ A	11.0m		15.0m		19.0m				27.0m				35.0m				39.0m			
	B	B	B	B	B	B	B	B	B	B	B	B	B	B	B	B	B	B	B	
0°	8.8	13.5	12.9	7.5	16.8	4.2	16.8	6.1	24.9	1.7	24.6	3.0	32.8	0.6	32.7	1.4	36.4	0.6		
Telescoping mode	I, II	I	I	II	I	II	I	II	I	II	I	II	I	II	II					

- A : Boom length(m)
- B : Load radius(m)
- C : Loaded boom angle (°)
- D : Minimum boom angle (°) for indicated length (no load)

RATED LIFTING CAPACITIES ISO 4305

ON OUTRIGGERS MID EXTENDED 6.7m SPREAD

360° ROTATION

C	43.0m Boom + 10.1m Jib					
	3.5° Tilt		25° Tilt		45° Tilt	
	R	W	R	W	R	W
80	9.9	4.2	13.4	3.5	15.8	2.9
79	11.0	4.2	14.3	3.3	16.7	2.9
78	12.1	4.2	15.3	3.2	17.6	2.8
77	13.1	4.1	16.3	3.1	18.4	2.7
76	14.0	3.9	17.2	3.0	19.4	2.7
75	15.0	3.8	18.2	3.0	20.0	2.6
73	16.8	3.5	19.9	2.8	21.9	2.5
70	19.5	3.2	22.6	2.6	24.1	2.3
68	21.2	3.0	24.2	2.5	25.7	2.3
65	23.8	2.8	26.6	2.3	28.0	2.2
63	25.4	2.4	28.0	2.0	29.3	1.9
60	27.4	1.8	30.0	1.6	31.1	1.5
58	29.1	1.5	31.5	1.3	32.5	1.2
55	31.2	1.1	33.5	1.0	34.3	0.9
53	32.6	0.9				

C	43.0m Boom + 17.7m Jib					
	3.5° Tilt		25° Tilt		45° Tilt	
	R	W	R	W	R	W
80	11.5	2.6	17.9	2.1	21.9	1.7
79	12.7	2.6	18.6	2.0	22.8	1.7
78	14.0	2.6	19.8	2.0	23.7	1.6
77	15.1	2.6	20.7	1.9	24.5	1.6
76	16.2	2.5	21.7	1.9	25.4	1.6
75	17.3	2.4	22.8	1.8	26.3	1.5
73	19.4	2.3	24.7	1.7	27.9	1.5
70	22.6	2.1	27.6	1.6	30.4	1.4
68	24.7	2.0	29.5	1.5	32.1	1.3
65	27.5	1.8	32.1	1.4	34.2	1.3
63	29.1	1.5	33.7	1.2	35.7	1.1
60	31.7	1.1	36.1	0.9		
58	33.4	0.9				

ON OUTRIGGERS MID EXTENDED 6.7m SPREAD

360° ROTATION

C	39.0m Boom(telescoping mode II) + 10.1m Jib					
	3.5° Tilt		25° Tilt		45° Tilt	
	R	W	R	W	R	W
80	9.5	4.6	13.0	3.8	15.4	3.2
79	10.5	4.6	13.8	3.6	16.1	3.1
78	11.4	4.6	14.7	3.5	17.0	3.0
77	12.4	4.5	15.6	3.4	17.9	2.9
76	13.4	4.4	16.6	3.3	18.8	2.9
75	14.2	4.2	17.4	3.2	19.5	2.8
73	16.0	3.9	19.1	3.1	20.9	2.7
70	18.5	3.6	21.4	2.8	23.1	2.5
68	20.1	3.4	23.1	2.7	24.4	2.4
65	22.5	3.1	25.2	2.6	26.6	2.3
63	24.0	3.0	26.8	2.5	27.8	2.3
60	26.3	2.7	28.9	2.3	29.7	2.2
58	27.5	2.4	29.9	2.1	30.9	2.0
55	29.5	1.9	31.8	1.7	32.6	1.6
53	30.8	1.7	32.9	1.5	33.7	1.4
50	32.6	1.4	34.6	1.2	35.2	1.2
48	33.7	1.2	35.7	1.1	36.1	1.0
45	35.4	1.0				

C	39.0m Boom(telescoping mode II) + 17.7m Jib					
	3.5° Tilt		25° Tilt		45° Tilt	
	R	W	R	W	R	W
80	11.0	2.8	17.1	2.3	21.1	1.8
79	12.1	2.8	17.9	2.2	22.0	1.8
78	13.2	2.8	19.0	2.1	22.8	1.7
77	14.3	2.8	19.9	2.1	23.6	1.7
76	15.5	2.7	21.0	2.0	24.5	1.7
75	16.4	2.7	21.9	1.9	25.3	1.6
73	18.4	2.5	23.8	1.8	27.0	1.6
70	21.4	2.3	26.4	1.7	29.2	1.5
68	23.2	2.2	28.1	1.6	30.7	1.4
65	26.0	2.0	30.5	1.5	32.8	1.4
63	27.8	1.9	32.3	1.5	34.2	1.3
60	30.3	1.8	34.7	1.4	36.4	1.3
58	31.8	1.6	36.1	1.3	37.7	1.2
55	34.1	1.3	38.1	1.0	39.4	0.9
53	35.5	1.1				

ON OUTRIGGERS MID EXTENDED 6.7m SPREAD

360° ROTATION

C	35m Boom(telescoping mode I) + 10.1m Jib					
	3.5° Tilt		25° Tilt		45° Tilt	
	R	W	R	W	R	W
80	8.2	5.6	11.6	4.5	13.9	3.7
79	9.0	5.6	12.4	4.4	14.7	3.6
78	9.9	5.6	13.3	4.3	15.6	3.6
77	10.8	5.6	14.1	4.2	16.2	3.5
76	11.6	5.5	14.8	4.0	16.8	3.4
75	12.4	5.3	15.5	3.9	17.6	3.4
73	14.0	5.0	17.2	3.7	19.0	3.2
70	16.2	4.6	19.2	3.5	20.9	3.1
68	17.8	4.3	20.6	3.4	22.2	3.0
65	20.0	4.0	22.7	3.2	24.1	2.9
63	21.4	3.8	24.0	3.1	25.2	2.8
60	23.3	3.1	25.9	2.7	26.9	2.5
58	24.5	2.7	26.9	2.4	27.9	2.2
55	26.2	2.2	28.6	2.0	29.5	1.8
53	27.5	1.9	29.7	1.7	30.4	1.6
50	29.2	1.6	31.2	1.4	31.9	1.3
48	30.3	1.4	32.3	1.2	32.8	1.2
45	32.0	1.1	33.7	1.0	34.1	0.9
43	33.0	0.9				

C	35m Boom(telescoping mode I) + 17.7m Jib					
	3.5° Tilt		25° Tilt		45° Tilt	
	R	W	R	W	R	W
80	9.6	3.2	15.8	2.6	20.0	2.1
79	10.6	3.2	16.7	2.6	20.8	1.9
78	11.6	3.2	17.5	2.5	21.6	1.9
77	12.5	3.2	18.5	2.4	22.3	1.9
76	13.5	3.2	19.4	2.4	23.1	1.9
75	14.4	3.2	20.2	2.3	23.9	1.9
73	16.3	3.1	22.1	2.2	25.6	1.9
70	19.1	2.9	24.4	2.1	27.7	1.8
68	20.7	2.7	26.0	2.0	29.1	1.7
65	23.3	2.5	28.2	1.9	31.1	1.7
63	25.0	2.4	29.8	1.8	32.3	1.6
60	27.3	2.2	31.8	1.7	34.1	1.5
58	28.9	1.8	33.1	1.5	35.3	1.3
55	31.2	1.5	35.1	1.2	37.0	1.1
53	32.6	1.2	36.3	1.0	38.0	0.9
50	34.7	1.0				

C :Loaded boom angle (°)
 R :Load radius(m)
 W :Rated lifting capacity(Unit:×1,000kg)

RATED LIFTING CAPACITIES ISO 4305

ON OUTRIGGERS MID EXTENDED 5.5m SPREAD																				
360° ROTATION (Unit: x 1,000kg)																				
B	11.0m		15.0m		19.0m				27.0m				35.0m				39.0m		43.0m	
	A	C	C	C	C	C	C	C	C	C	C	C	C	C	C	C	C	C		
3.0	68	55.6	74	40.8	78	32.0	78	22.0												
3.5	65	49.4	72	40.8	76	32.0	76	22.0												
4.0	62	44.3	70	40.8	75	32.0	75	22.0												
4.5	59	40.0	68	39.5	73	32.0	73	22.0	78	22.0	79	17.0								
5.0	56	36.3	66	33.2	72	29.6	71	22.0	77	21.3	77	17.0								
5.5	52	32.7	64	28.5	70	25.5	70	22.0	76	20.3	76	17.0								
6.0	48	28.4	62	24.9	69	22.4	68	22.0	75	19.4	75	17.0								
6.5	44	24.2	59	21.9	67	19.8	66	22.0	74	18.5	74	16.2	79	14.0	79	12.0				
7.0	40	20.8	57	19.5	65	17.7	65	20.4	73	16.8	73	15.6	78	13.5	78	11.7				
7.5	33	18.1	54	17.5	63	15.9	63	18.5	72	15.2	72	14.9	77	13.0	77	11.3				
8.0	28	16.0	52	15.5	62	14.3	61	16.9	71	13.9	71	14.4	76	12.6	77	10.9	78	10.0		
8.5	20	14.2	50	13.7	60	13.0	59	15.5	70	12.8	70	13.9	75	12.1	76	10.5	77	10.0		
9.0			47	12.3	58	11.8	58	14.2	68	11.7	69	13.4	74	11.2	75	10.2	77	10.0	79	9.0
10.0			40	9.9	54	9.6	54	11.8	66	10.0	66	11.6	73	9.7	73	9.5	75	9.6	78	8.7
11.0			33	8.1	50	7.8	50	10.0	64	8.6	64	10.2	71	8.5	71	8.9	74	8.9	77	8.2
12.0			24	6.7	46	6.5	45	8.5	61	7.5	61	8.9	69	7.4	70	8.5	72	7.9	75	7.2
14.0					36	4.4	35	6.4	56	5.4	56	6.8	66	5.8	66	6.9	69	6.3	72	5.7
16.0					22	3.0	21	4.9	51	4.0	51	5.3	62	4.4	62	5.4	65	5.0	69	4.6
18.0									45	2.9	45	4.2	58	3.4	59	4.3	62	3.9	66	3.6
20.0									38	2.1	37	3.3	54	2.6	55	3.5	58	3.1	62	2.8
22.0									30	1.5	29	2.7	49	1.9	50	2.8	55	2.5	59	2.1
24.0									18	0.9	15	2.1	45	1.4	45	2.3	51	1.9	55	1.6
26.0													39	0.9	40	1.8	46	1.5	52	1.2
28.0															34	1.5	42	1.1		
30.0															27	1.2				
32.0															16	0.9				
D	0										26		0		31		43			
Telescoping conditions (%)																				
Telescoping mode	I, II		I		I		II		I		II		I		II		II		I, II	
2nd boom	0		50		100		0		100		0		100		0		50		100	
3rd boom	0		0		0		33		33		66		66		100		100		100	
4th boom	0		0		0		33		33		66		66		100		100		100	
Top boom	0		0		0		33		33		66		66		100		100		100	

LIFTING CAPACITIES AT ZERO DEGREE BOOM ANGLE ON OUTRIGGERS MID EXTENDED																				
5.5m SPREAD 360° ROTATION																				
C	11.0m		15.0m		19.0m				27.0m				35.0m							
	A	B	B	B	B	B	B	B	B	B	B	B	B	B	B	B	B	B		
0°	8.8	12.5	12.9	5.6	16.9	2.5	16.8	4.5	24.9	0.7	24.5	2.0			32.8	0.6				
Telescoping mode	I, II		I		I		II		I		II				II					

- A : Boom length(m)
- B : Load radius(m)
- C : Loaded boom angle (°)
- D : Minimum boom angle (°) for indicated length (no load)

RATED LIFTING CAPACITIES

ISO 4305

ON OUTRIGGERS MID EXTENDED 5.5m SPREAD													
360° ROTATION													
C	43.0m Boom + 10.1m Jib						C	43.0m Boom + 17.7m Jib					
	3.5° Tilt		25° Tilt		45° Tilt			3.5° Tilt		25° Tilt		45° Tilt	
	R	W	R	W	R	W		R	W	R	W	R	W
80	9.9	4.2	13.2	3.5	15.7	2.9	80	11.5	2.6	17.9	2.1	22.0	1.7
79	10.9	4.2	14.3	3.3	16.5	2.9	79	12.6	2.6	18.4	2.0	22.5	1.7
78	12.1	4.2	15.4	3.2	17.7	2.8	78	13.8	2.6	19.8	2.0	23.6	1.6
77	13.1	4.1	16.3	3.1	18.4	2.7	77	14.9	2.6	20.7	1.9	24.4	1.6
76	14.0	3.9	17.2	3.0	19.4	2.7	76	16.2	2.5	21.7	1.9	25.4	1.6
75	15.0	3.8	18.2	3.0	20.1	2.6	75	17.3	2.4	22.8	1.8	26.4	1.5
73	16.7	3.5	19.9	2.8	21.8	2.5	73	19.5	2.3	24.8	1.7	28.0	1.5
70	19.3	2.8	22.3	2.4	24.1	2.2	70	22.3	1.8	27.4	1.4	30.3	1.3
68	20.9	2.3	23.9	2.0	25.5	1.9	68	24.0	1.4	29.1	1.1	31.8	1.0
65	23.2	1.7	26.1	1.5	27.6	1.4	65	26.9	1.0				
63	24.7	1.4	27.5	1.2	28.9	1.1							
60	27.0	1.0											

ON OUTRIGGERS MID EXTENDED 5.5m SPREAD													
360° ROTATION													
C	39.0m Boom(telescoping mode II) + 10.1m Jib						C	39.0m Boom(telescoping mode II) + 17.7m Jib					
	3.5° Tilt		25° Tilt		45° Tilt			3.5° Tilt		25° Tilt		45° Tilt	
	R	W	R	W	R	W		R	W	R	W	R	W
80	9.6	4.6	13.1	3.8	15.5	3.2	80	11.0	2.8	17.1	2.3	21.1	1.8
79	10.5	4.6	13.8	3.6	16.1	3.1	79	12.1	2.8	18.1	2.2	22.0	1.8
78	11.4	4.6	14.7	3.5	17.0	3.0	78	13.2	2.8	18.9	2.1	22.6	1.7
77	12.4	4.5	15.6	3.4	17.8	2.9	77	14.3	2.8	20.0	2.1	23.6	1.7
76	13.4	4.4	16.6	3.3	18.7	2.9	76	15.3	2.7	20.8	2.0	24.5	1.7
75	14.2	4.2	17.4	3.2	19.4	2.8	75	16.4	2.7	21.8	1.9	25.3	1.6
73	15.9	3.9	19.1	3.1	21.0	2.7	73	18.4	2.5	23.7	1.8	26.9	1.6
70	18.5	3.6	21.4	2.8	23.1	2.5	70	21.2	2.3	26.4	1.7	29.2	1.5
68	20.1	3.4	22.9	2.7	24.5	2.4	68	23.2	2.2	28.2	1.6	30.7	1.4
65	22.5	2.8	25.2	2.3	26.4	2.1	65	25.8	1.8	30.5	1.4	32.6	1.2
63	24.1	2.3	26.8	2.0	27.8	1.8	63	27.8	1.5	32.4	1.2	34.2	1.0
60	25.8	1.8	28.4	1.6	29.5	1.4	60	29.9	1.1				
58	27.2	1.5	29.6	1.3	30.7	1.2	58	31.4	0.9				
55	29.2	1.2	31.4	1.0	32.4	0.9							
53	30.5	1.0											

ON OUTRIGGERS MID EXTENDED 5.5m SPREAD													
360° ROTATION													
C	35m Boom(telescoping mode I) + 10.1m Jib						C	35m Boom(telescoping mode I) + 17.7m Jib					
	3.5° Tilt		25° Tilt		45° Tilt			3.5° Tilt		25° Tilt		45° Tilt	
	R	W	R	W	R	W		R	W	R	W	R	W
80	8.2	5.6	11.7	4.5	14.1	3.7	80	9.6	3.2	15.9	2.6	20.1	2.1
79	9.0	5.6	12.4	4.4	14.7	3.6	79	10.6	3.2	16.6	2.6	20.8	1.9
78	9.9	5.6	13.2	4.3	15.5	3.6	78	11.6	3.2	17.7	2.5	21.7	1.9
77	10.7	5.6	14.0	4.2	16.1	3.5	77	12.4	3.2	18.4	2.4	22.3	1.9
76	11.6	5.5	14.8	4.0	16.8	3.4	76	13.5	3.2	19.3	2.4	23.2	1.9
75	12.4	5.3	15.5	3.9	17.5	3.4	75	14.4	3.2	20.2	2.3	24.0	1.9
73	14.0	5.0	17.0	3.7	18.9	3.2	73	16.2	3.1	22.0	2.2	25.6	1.9
70	16.3	4.6	19.2	3.5	20.0	3.1	70	19.0	2.9	24.0	2.1	27.6	1.8
68	17.7	3.9	20.6	3.3	22.2	3.0	68	20.6	2.7	25.9	2.0	29.0	1.7
65	19.7	3.1	22.4	2.6	23.8	2.4	65	23.3	2.2	28.1	1.6	31.0	1.4
63	21.0	2.7	23.7	2.3	25.0	2.1	63	24.9	1.8	29.5	1.4	32.3	1.2
60	22.9	2.1	25.5	1.8	26.7	1.6	60	27.3	1.3	31.5	1.0		
58	24.2	1.7	26.6	1.5	27.7	1.4	58	28.7	1.1				
55	26.0	1.3	28.4	1.2	29.3	1.1							
53	29.2	1.1	29.5	1.0									

C :Loaded boom angle (°)
 R :Load radius(m)
 W :Rated lifting capacity(Unit:×1,000kg)

RATED LIFTING CAPACITIES ISO 4305

ON OUTRIGGERS MIN EXTENDED 2.7m SPREAD																					
360° ROTATION (Unit: x 1,000kg)																					
B	A	11.0m		15.0m		19.0m			27.0m			35.0m			39.0m		43.0m				
	c	c	c	c	c	c	c	c	c	c	c	c	c	c	c	c	c				
3.0	68	26.3	74	22.3	78	19.3	78	22.0													
3.5	65	21.4	72	18.3	76	16.0	76	18.7													
4.0	62	17.8	70	15.4	75	13.5	75	16.1													
4.5	59	15.0	68	13.1	73	11.5	73	14.0	78	10.9	78	12.5									
5.0	55	12.9	66	11.3	72	9.9	71	12.3	77	9.5	77	11.1									
5.5	52	11.2	64	9.8	70	8.6	69	10.9	76	8.4	76	10.0									
6.0	48	9.8	61	8.5	68	7.5	68	9.8	75	7.5	75	9.0									
6.5	44	8.6	59	7.4	67	6.6	66	8.8	74	6.7	74	8.2	78	6.4	79	7.5					
7.0	40	7.6	57	6.5	65	5.7	64	7.9	73	6.0	72	7.4	77	5.8	78	6.9					
7.5	34	6.6	55	5.7	63	5.0	63	7.1	71	5.3	71	6.8	76	5.2	77	6.3					
8.0	28	5.7	52	5.0	61	4.3	61	6.5	70	4.8	70	6.2	75	4.7	76	5.8	77	5.1			
8.5	19	5.0	49	4.4	59	3.8	59	5.9	69	4.3	69	5.7	75	4.3	75	5.4	77	4.7			
9.0			47	3.9	58	3.3	57	5.3	68	3.8	68	5.3	74	3.9	74	5.0	76	4.3	78	3.8	
10.0			41	2.9	54	2.4	53	4.4	66	3.1	65	4.5	72	3.2	72	4.3	74	3.7	76	3.2	
11.0			33	2.2	49	1.7	49	3.7	63	2.4	63	3.8	70	2.6	71	3.7	73	3.1	75	2.6	
12.0			25	1.5	45	1.1	45	3.1	61	1.9	60	3.2	69	2.1	69	3.2	71	2.6	73	2.2	
14.0								35	2.0	56	1.0	55	2.3	65	1.3	65	2.3	68	1.8	70	1.4
16.0								20	1.3			49	1.6			62	1.7	64	1.2		
18.0												38	1.1			58	1.2				
D	0				21		0		44		27		57		49		57		64		
Telescoping conditions (%)																					
Telescoping mode	I, II	I	I	I	II	I	II	I	II	I	II	I	II	II	II	I, II					
2nd boom	0	50	100	0	100	0	100	0	100	0	100	0	100	0	50	100					
3rd boom	0	0	0	33	33	66	66	100	100	100	100	100	100	100	100	100					
4th boom	0	0	0	33	33	66	66	100	100	100	100	100	100	100	100	100					
Top boom	0	0	0	33	33	66	66	100	100	100	100	100	100	100	100	100					

LIFTING CAPACITIES AT ZERO DEGREE BOOM ANGLE ON OUTRIGGERS MIN EXTENDED										
2.7m SPREAD 360° ROTATION										
C	A	11.0m		15.0m		19.0m				
	B	B	B	B	B	B	B	B	B	B
0°	8.7	4.5	12.9	0.9		16.7	1.1			
Telescoping mode	I, II	I				II				

- A : Boom length(m)
- B : Load radius(m)
- C : Loaded boom angle (°)
- D : Minimum boom angle (°) for indicated length (no load)

NOTES FOR "ON OUTRIGGERS" TABLE

1. Rated lifting capacities shown in the table are based on condition that crane is set on firm level surface. Those above thick lines are based on crane strength and those below, on its stability.
2. Rated lifting capacities based on crane stability are according to ISO4305.
3. The mass of the hook (550 kg for 60 t capacity, 460 kg for 35 t capacity, 150 kg for 5.6 t capacity), slings and all similarly used load handling devices must be considered as part of the load and must be deducted from the lifting capacities.
4. For rated lifting capacity of single top, reduce the rated lifting capacities of relevant boom according to a weight reduction for auxiliary load handling equipment. Capacities of single top shall not exceed 5,600 kg including main boom hook mass and the net capacity must be so reduced.
5. Standard number of parts of line for each boom length is as shown below. Load per line should not surpass 54.9 kN {5,600 kgf} for main winch and auxiliary winch.

Boom length	11.0m	11.0m to 15.0m		15.0m to 19.0m	19.0m to 43.0m	Single top Jib
Telescoping mode	I, II	I	II	I, II	I, II	I, II
Number of parts of line	12	8	6	6	4	1

The lifting capacity data stored in the AUTOMATIC MOMENT LIMITER (AML) is based on the standard number of parts of line listed in the chart.

Maximum lifting capacity is restricted by the number of parts of line of AUTOMATIC MOMENT LIMITER (AML).

6. The lifting capacity for over-side area differs depending on the outrigger extension width. Work with the capacity corresponding to the extension width. The lifting capacities for over-front and over-rear areas are for "outriggers fully extended". However, the areas (angle **a**) differ depending on the outrigger extension width.

Outriggers extended width	6.7m (middle)	5.5m (middle)	2.7m (minimum)
Angle a °	60	40	15

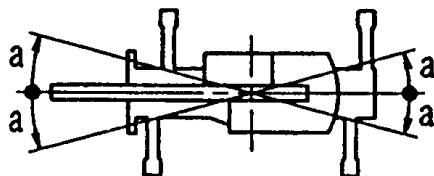

RATED LIFTING CAPACITIES ISO 4305

ON RUBBER STATIONARY (Unit: x 1,000kg)												
A \ B	Over Front						360° Rotation					
	11.0m		19.0m		27.0m		11.0m		19.0m		27.0m	
	C		C		C		C		C		C	
3.0	68	29.5					68	18.6				
3.5	65	27.8					65	14.8				
4.0	62	25.5	75	15.9			62	12.5	75	10.0		
4.5	59	23.0	73	15.9			59	10.6	73	10.0		
5.0	55	20.7	71	15.9			55	9.1	71	9.0		
5.5	52	18.2	70	15.9			52	7.7	70	7.8		
6.0	48	15.7	68	15.9	75	10.0	49	6.6	68	6.6	75	7.5
6.5	44	14.0	66	14.5	74	10.0	44	5.6	66	5.8	74	6.5
7.0	40	12.5	65	13.0	73	10.0	39	4.8	65	5.1	73	5.5
7.5	34	11.0	63	11.6	72	10.0	34	4.2	63	4.5	72	4.7
8.0	28	9.8	61	10.5	71	9.7	29	3.6	61	4.0	71	4.2
8.5	20	8.5	59	9.4	70	9.2	20	3.1	59	3.5	70	3.8
9.0			58	8.4	69	8.8			58	3.0	68	3.3
10.0			54	7.0	66	7.6			54	2.4	66	2.7
11.0			50	6.0	64	6.5			50	1.8	64	2.1
12.0			46	5.1	61	5.5			46	1.3	61	1.7
14.0			36	3.4	56	4.1					56	0.9
16.0			22	2.4	51	3.0						
18.0					45	2.3						
20.0					38	1.5						
22.0					30	1.0						
D	0		18		0		21		45			
Telescoping conditions (%)												
Telescoping mode	I, II		II		II		I, II		II		II	
2nd boom	0		0		0		0		0		0	
3rd boom	0		33		66		0		33		66	
4th boom	0		33		66		0		33		66	
Top boom	0		33		66		0		33		66	

LIFTING CAPACITIES AT ZERO DEGREE BOOM ANGLE ON RUBBER STATIONARY											
A \ B	Over Front						360° Rotation				
	11.0m		19.0m		27.0m		11.0m		19.0m		27.0m
	B		B		B		B		B		B
0	8.8	8.0	16.9	2.1			8.8	2.8			

ON RUBBER CREEP (Unit: x 1,000kg)												
A \ B	Over Front						360° Rotation					
	11.0m		19.0m		27.0m		11.0m		19.0m		27.0m	
	C		C		C		C		C		C	
3.0	68	22.7					68	15.0				
3.5	65	20.2					65	13.0				
4.0	62	18.2	74	15.9			62	11.2	74	10.0		
4.5	59	16.5	73	15.9			59	9.5	73	9.8		
5.0	55	15.1	72	15.0			56	8.2	71	8.4		
5.5	52	13.6	70	13.9			52	7.0	70	7.2		
6.0	48	12.4	68	12.8	75	10.0	48	5.9	68	6.2	75	6.7
6.5	44	11.4	66	11.9	74	10.0	44	5.0	66	5.4	74	5.9
7.0	39	10.5	65	11.0	73	10.0	40	4.3	65	4.7	73	5.2
7.5	34	9.5	63	10.1	72	10.0	35	3.7	63	4.1	72	4.6
8.0	28	8.5	61	9.0	71	9.3	28	3.1	61	3.6	71	4.1
8.5	20	7.6	59	8.0	70	8.6	20	2.5	60	3.1	70	3.6
9.0			58	7.3	69	8.0			58	2.7	68	3.2
10.0			54	6.0	66	6.8			54	2.0	66	2.6
11.0			50	5.1	64	5.8			50	1.5	64	2.0
12.0			45	4.2	61	4.9			46	1.1	61	1.5
14.0			36	2.9	56	3.6						
16.0			21	1.8	51	2.6						
18.0					45	1.9						
20.0					38	1.3						
D	0		18		0		21		50			
Telescoping conditions (%)												
Telescoping mode	I, II		II		II		I, II		II		II	
2nd boom	0		0		0		0		0		0	
3rd boom	0		33		66		0		33		66	
4th boom	0		33		66		0		33		66	
Top boom	0		33		66		0		33		66	

LIFTING CAPACITIES AT ZERO DEGREE BOOM ANGLE ON RUBBER STATIONARY											
A \ B	Over Front						360° Rotation				
	11.0m		19.0m		27.0m		11.0m		19.0m		27.0m
	B		B		B		B		B		B
0	8.8	7.3	16.9	1.5			8.8	2.3			

A : Boom length(m)
 B : Load radius(m)
 C : Loaded boom angle (°)
 D : Minimum boom angle (°) for indicated length (no load)

NOTES FOR "ON RUBBER" TABLES

1. Rated lifting capacities shown in the table are based on condition that crane is set on firm level surface, with suspension lock applied. Those above thick lines are based on tire capacity and those below, on crane stability. They are based on actual load radius increased by tire deformation and boom deflection.
2. Rated lifting capacities based on crane stability are according to ISO4305.
3. The mass of the hook (550 kg for 60t capacity, 460 kg for 35t capacity, 150 kg for 5.6t capacity), slings and all similarly used load handling devices must be considered as part of the load and must be deducted from the lifting capacities.
4. For rated lifting capacity of single top, reduce the rated lifting capacities of relevant boom according to weight reductions for auxiliary load handling equipment. Capacities of single top shall not exceed 5,600 kg including main hook.
5. On rubber lifting with "jib" is not permitted. Maximum permissible boom length is 27.0 m.
6. CREEP is motion for crane not to travel more than 60 m in any 30 minute period and to travel at the speed of less than 1.6 km/h.
7. During "CREEP" duties travel slowly and keep the lifting load as close to the ground as possible, and especially avoid any abrupt steering, accelerating or braking.
8. Do not operate the crane while carrying the load.
9. Tires should be inflated to their correct air pressure.

Tires	Air pressure
29.5-25 22PR	420 kPa
29.5-25 28PR	450 kPa

10. For CREEP operation, choose the drive mode and proper gear according to the road or working condition.
11. Standard number of parts of line for on rubber operation should be according to the following table.

Load per line should not surpass 54.9 kN {5,600 kgf} for main winch and auxiliary winch.

Boom length	11.0m	11.0m to 27.0m	Single top
Telescoping mode	I, II	II	I, II
Number of parts of line	6	4	1

The lifting capacity data stored in the AUTOMATIC MOMENT LIMITER (AML) is based on the standard number of parts of line listed in the chart.

Maximum lifting capacity is restricted by the number of parts of line of AUTOMATIC MOMENT LIMITER (AML).

WORKING AREA

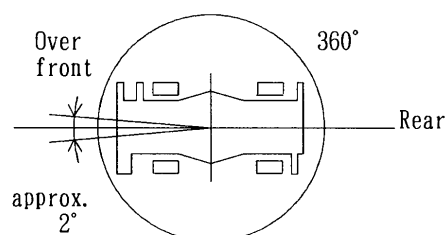

Without outriggers "Over front" operation should be performed within 2 degrees in front of chassis.

WORKING RANGE CHART

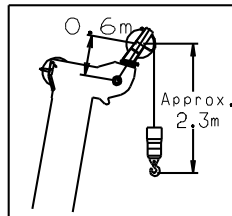
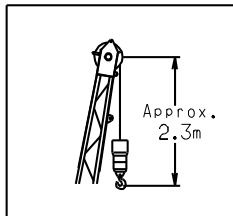
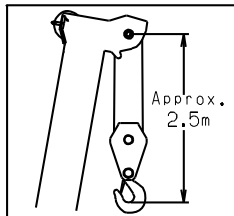
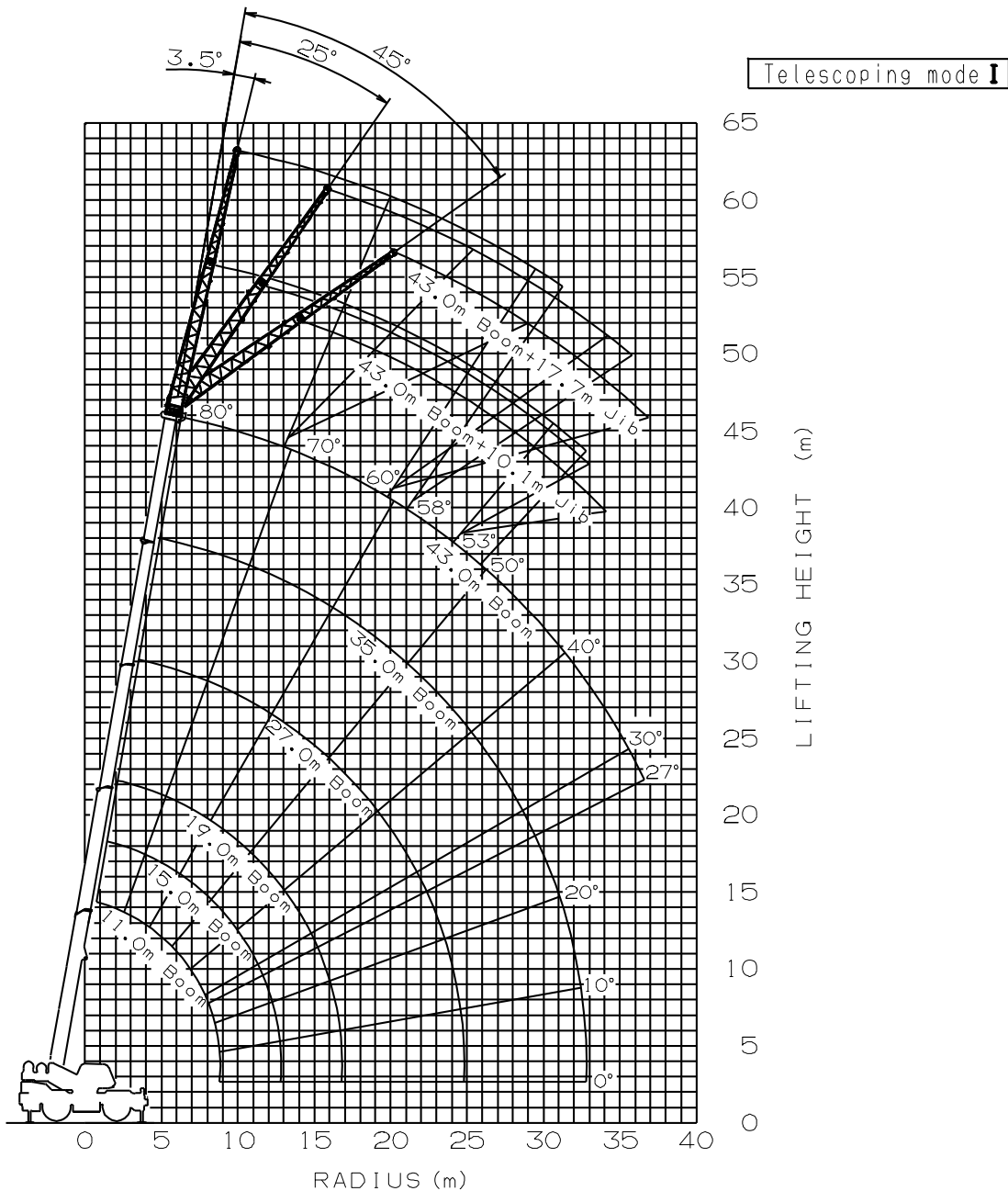

NOTE: 1. Boom and jib geometry shown are for unloaded condition and machine standing level on firm supporting surface.
 Boom deflection and subsequent radius and boom angle change must be accounted for when applying load to hook.

Boom Length

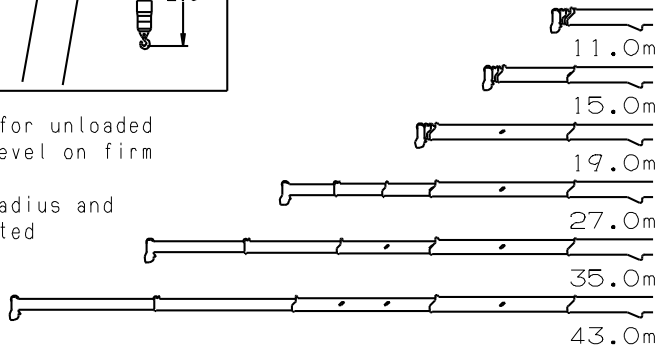

WORKING RANGE CHART

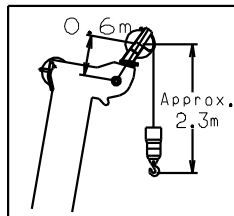
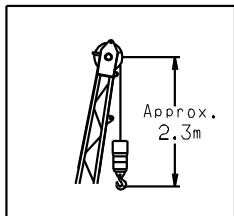
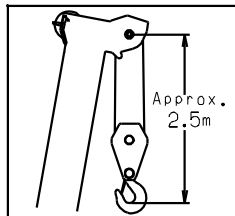
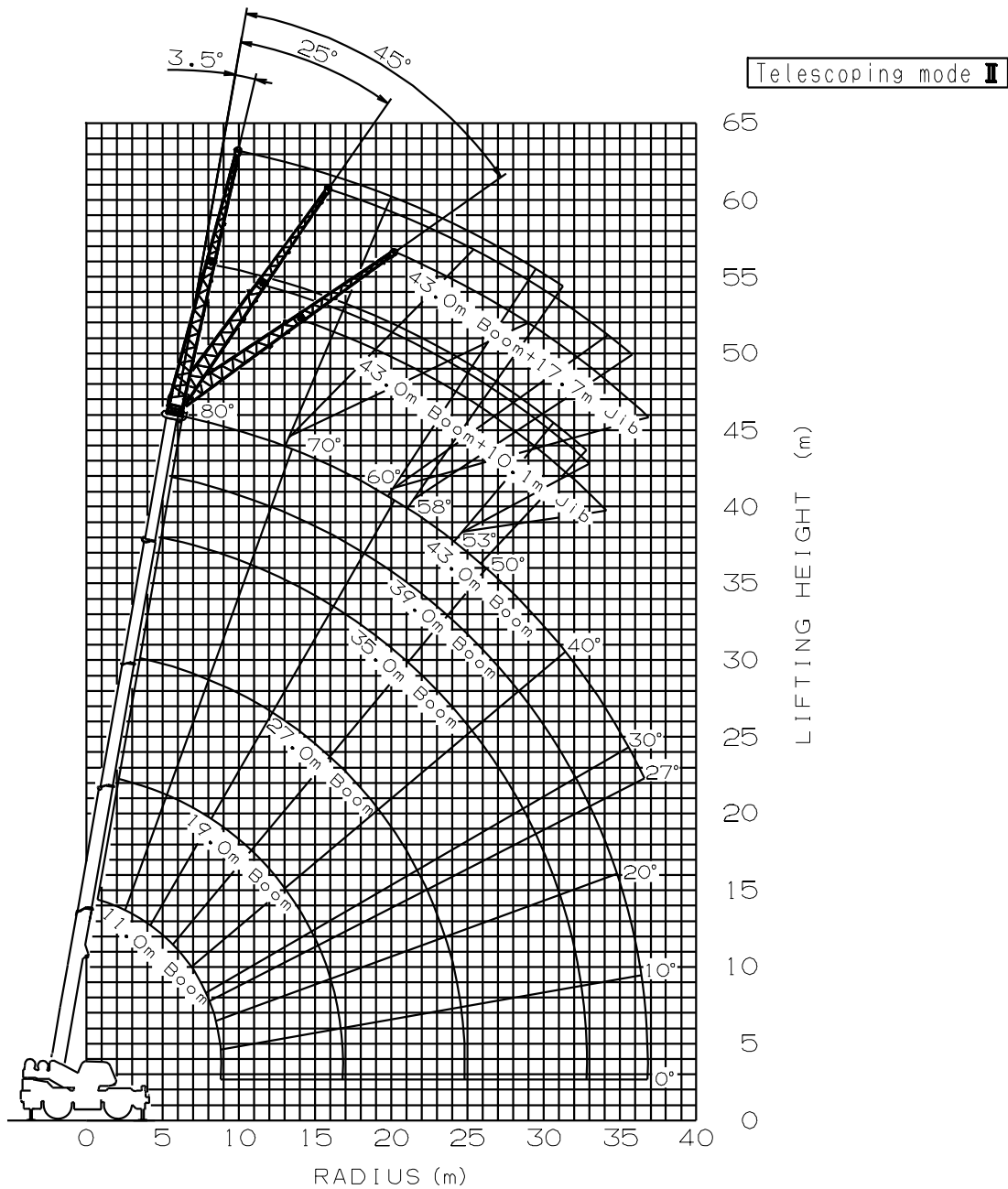

Boom Length

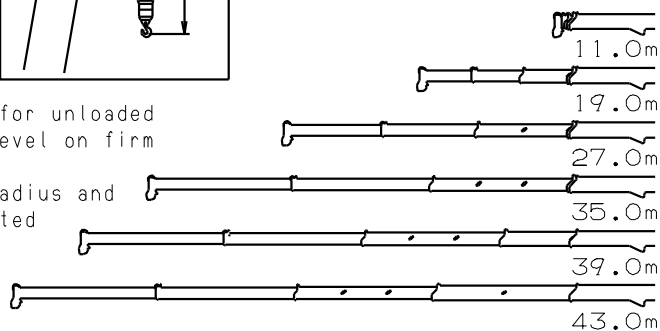

NOTE: 1. Boom and jib geometry shown are for unloaded condition and machine standing level on firm supporting surface.
 Boom deflection and subsequent radius and boom angle change must be accounted for when applying load to hook,

DIMENSIONS

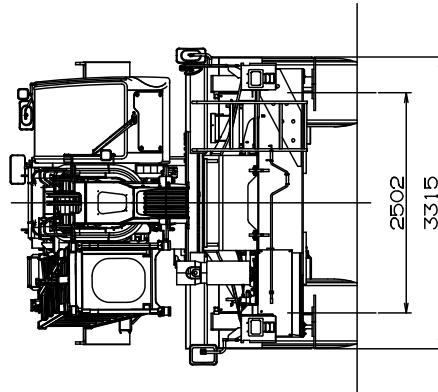
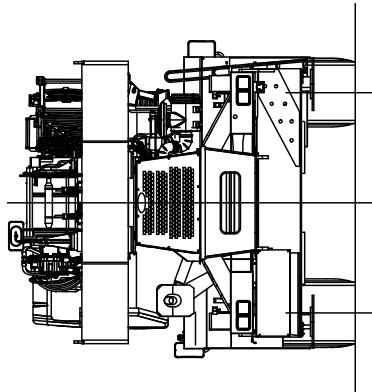
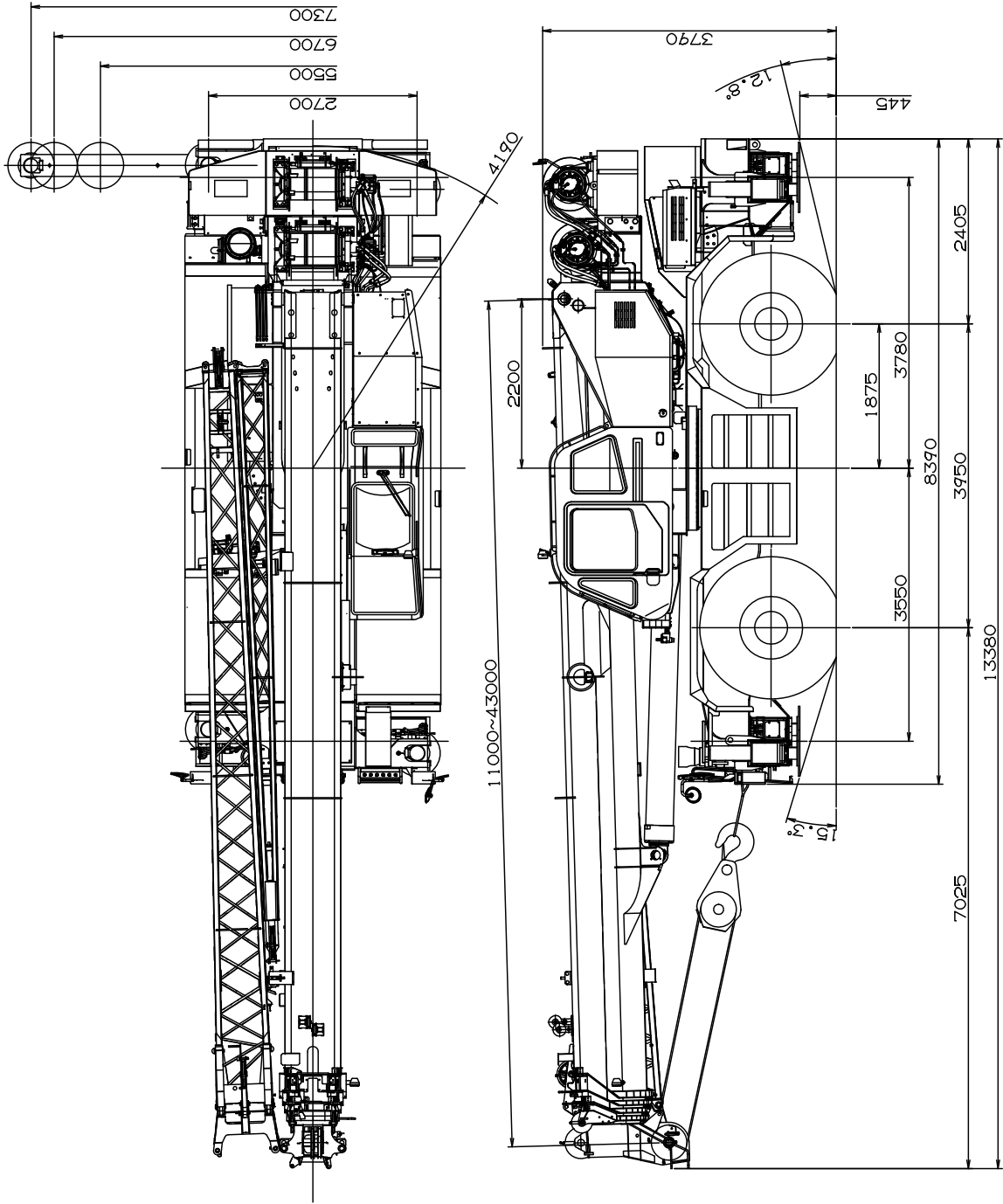

GR-600EX Axle Weight Distribution Chart

UNIT : kg

	GW	Front	Rear
Basic standard machine includes: 5-section boom (11.0 m - 43.0 m) 2-stage jib (10.1 m, 17.7 m) Mitsubishi 6M60-TL 29.5-25 tires Single top 5.6 ton hook block	43,760	21,545	22,215
Add: 1. 60 ton 6 sheaves hook block 2. 35 ton 3 sheaves hook block	+550 +460	+980 +820	-430 -360
Remove: 1. 5.6 ton hook block 2. Top jib 3. Base jib 4. Counter weight with auxiliary winch and wire rope	-150 -335 -865 -5,670	-215 -365 -1,480 +2,500	65 +30 +615 -8170