

## TADANO ROUGH TERRAIN CRANE

**MODEL : GR-300EX**

(Left-hand steering)

## GENERAL DATA

<u>CRANE CAPACITY</u>		30,000 kg at 3.0 m
<u>BOOM</u>		4-section, 9.7 m - 31.0 m
<u>DIMENSION</u>		
Overall length	approx.	11,245 mm
Overall width	approx.	2,620 mm
Overall height	approx.	3,535 mm
<u>MASS</u>		
Gross vehicle mass	approx.	26,370 kg
-front axle	approx.	12,420 kg
-rear axle	approx.	13,950 kg
<u>PERFORMANCE</u>		
Max. traveling speed	computed	47 km/h
Gradeability (tan $\theta$ )	computed	93% (at stall) *57%

\*Machine should be operated within the limit of engine crankcase design (30° :Cummins QSB6.7).

Specifications are subject to change without notice.

## CRANE SPECIFICATIONS

<u>MODEL</u>	GR-300EX
<u>CAPACITY</u>	30,000 kg at 3.0 m
<u>BOOM</u>	<p>Four section full power partially synchronized telescoping boom of round hexagonal box construction with 4 sheaves at boom head. The synchronization system consists of 2 telescope cylinders, extension cables and retraction cables.</p> <p>Hydraulic cylinders fitted with holding valves.</p> <p>Fully retracted length..... 9.7 m</p> <p>Fully extended length..... 31.0 m</p> <p>Extension speed..... 21.3 m in 91 s</p>
<u>SINGLE TOP (AUXILIARY BOOM SHEAVE)</u>	Single sheave. Mounted to main boom head for single line work.
<u>ELEVATION</u>	<p>By a double-acting hydraulic cylinder, fitted with holding valve.</p> <p>Automatic speed reduction and soft stop function.</p> <p>Elevation speed..... 0° to 81° in 44 s</p>
<u>HOIST - Main winch</u>	<p>Variable speed type with grooved drum driven by hydraulic axial piston motor through winch speed reducer. Power load lowering and hoisting.</p> <p>Equipped with automatic brake (Neutral brake) and counterbalance valve.</p> <p>Controlled independently of auxiliary winch.</p> <p>Single line pull.....38.2 kN {3,900 kgf}</p> <p>Single line speed.....118 m/min (at the 4th layer)</p> <p>Wire rope..... Spin-resistant type</p> <p>Diameter x length.....16 mm x 170 m</p>
<u>HOOK BLOCK - 30 t capacity</u>	4 sheaves, swivel type hook with safety latch.
<u>HOOK BLOCK- 3.9 t capacity</u>	Swivel hook with safety latch for single line use.
<u>SWING</u>	<p>Hydraulic axial piston motor driven through planetary speed reducer. Continuous 360° full circle swing on ball bearing slew ring.</p> <p>Equipped with manually locked/released swing brake.</p> <p>Swing speed.....2.7 min<sup>-1</sup> {rpm}</p>

HYDRAULIC SYSTEM

Pumps.....Two variable piston pumps for telescoping, elevating and winches.  
Tandem gear pump for steering, swing and optional equipment.

Control valves..... Multiple valves actuated by pilot pressure with integral pressure relief valves.

Circuit..... Equipped with air cooled type oil cooler. Oil pressure appears on AML display for main circuit.

Hydraulic oil tank capacity...  
approx. 380 liters

Filters..... Return line filter

CRANE CONTROL

By 4 control levers for swing, boom hoist, main winch, boom telescoping or auxiliary winch with 2 control pedals for boom hoist and boom telescoping based on ISO standard layout. Control lever stands can change neutral positions and tilt for easy access to cab.

CAB

Both crane and drive operations can be performed from one cab mounted on rotating superstructure. One sided one-man type, steel construction with sliding door access and tinted safety glass windows opening at side. Door window is powered control.

Operator's 3 way adjustable seat with headrest and armrest. Hot water cab heater and air conditioning.(Optional)

TADANO Automatic Moment Limiter (Model:AML-L)

Main unit in crane cab gives audible and visual warning of approach to overload. Automatically cuts out crane motions before overload. With working range (load radius and/or boom angle and/or tip height and/or swing range) limit function and adjustable boom elevation speed.

Automatic Speed Reduction and Soft Stop function on boom elevation and swing.

Nine functions are displayed :

- Either moment as percentage or main hydraulic pressure
- Either boom angle or moment %
- Either boom length or potential hook height
- Either actual load radius or swing angle
- Actual hook load
- Permissible load
- Either jib offset angle or number of parts of line of rope
- Boom position indicator
- Either outrigger position or on-tire indicator

OUTRIGGERS

Hydraulically operated H-type outriggers. Each outrigger controlled simultaneously or independently from the cab. Equipped with sight level gauge. Floats mounted integrally with the jacks retract to within vehicle width. All cylinders fitted with pilot check valves. Crane operation with different extended length of each outrigger. Equipped with extension width detector for each outrigger.

Extended width	
Fully .....	6,300 mm
Middle .....	5,900 mm
Middle .....	5,000 mm
Minimum .....	2,200 mm
Float size (Diameter) .....	400 mm

COUNTERWEIGHT

Integral with swing frame  
 Mass ..... 2,380 kg

---

NOTE : Each crane motion speed is based on unladen conditions.

## CARRIER SPECIFICATIONS

<u>TYPE</u>	Rear engine, left hand steering, driving axle 2-way selected type (by manual switch). 4 x 2 front drive 4 x 4 front and rear drive
<u>FRAME</u>	High-tensile steel, all welded mono-box construction.
<u>ENGINE</u>	Model..... Cummins QSB6.7 [EUROMOT Stage IIIA] Type..... 4 cycle, turbo charged and after cooled, 6 cylinder in line, direct injection, water cooled diesel engine. Piston displacement.....6,700 cm <sup>3</sup> Bore x stroke.....107 mm x 124 mm Max. output ..... 160 kW {217 PS} at 2,500 min <sup>-1</sup> {rpm} Max. torque ..... 843 N·m {86 kgfm} at 1,600 min <sup>-1</sup> {rpm}
<u>TRANSMISSION</u>	Electronically controlled full automatic transmission. Torque converter driving full powershift with driving axle selector. 6 forward and 2 reverse speeds. 4 speeds - High range - 2 wheel drive ; 4 wheel drive 4 speeds - Low range - 4 wheel drive
<u>AXLES</u>	Front ..... Full floating type, steering and driving axle with planetary reduction. Rear..... Full floating type, steering and driving axle with planetary reduction. Non-spin differential.
<u>STEERING</u>	Hydraulic power steering controlled by steering wheel. Three steering modes available: 2-wheel front 4-wheel coordinated 4-wheel crab
<u>SUSPENSION</u>	Front.....Semi-elliptic leaf springs with hydraulic lockout device. Rear .....Semi-elliptic leaf springs with hydraulic lockout device.
<u>BRAKE SYSTEM</u>	Service.....Air over hydraulic disc brakes on all 4 wheels. Parking / Emergency..... Spring applied-air released brake acting on input shaft of front axle. Auxiliary...Electro-pneumatic operated exhaust brake.
<u>ELECTRIC SYSTEM</u>	24 V DC. 2 batteries of 12 V - 120 Ah capacity.
<u>FUEL TANK CAPACITY</u>	300 liters
<u>TIRES</u>	Front.....445 / 95 R 25(OR), Single x 2 Rear .....445 / 95 R 25(OR), Single x 2
<u>TURN RADIUS</u>	Min. turning radius (at center of extreme outer tire) 2-wheel steering.....9.55 m 4-wheel steering.....5.7 m

## E Q U I P M E N T

### STANDARD EQUIPMENT

Automatic moment limiter(AML-L)  
 External lamp (AML)  
 Pendant type over-winding cutout  
 Winch automatic fail-safe brake  
 Hook safety latch  
 Pilot check valves  
 Holding valves  
 Counterbalance valves  
 Hydraulic pressure relief valves  
 Swing brake  
 Swing lock (360° positive swing lock)  
 Boom angle indicator  
 Boom elevation foot pedal  
 Boom telescoping foot pedal  
 Outrigger extension width detector  
 Sight level gauge  
 Hydraulic oil cooler  
 Electric windshield wiper and washer  
 Roof window wiper and washer  
 Power window (Cab door)  
 Tachometer/Speedometer  
 3 way adjustable cloth seat with seat belt, headrest and armrest  
 Cab floor mat  
 Sun visor (Front and roof)  
 Automatic drive system  
 Transmission neutral position engine start  
 Overshift prevention  
 Parking braked travel warning  
 Tilt-telescope steering wheel  
 Back-up alarm  
 Air cleaner dust indicator  
 Air dryer  
 Water separator with filter  
 Engine over-run alarm  
 Hydraulic lockout suspension  
 Non-spin differential (Rear)  
 Towing eyes - front and rear

### OPTIONAL EQUIPMENT

Winch drum rotation indicator (Visual type)  
 Cable follower  
 Electric fan  
 Tire inflation kit  
 Hot water cab heater, air conditioner and defroster  
 Emergency steering

## RATED LIFTING CAPACITIES

ISO 4305

Unit: x1000kg

ON OUTRIGGERS FULLY EXTENDED 6.3m SPREAD								
360° ROTATION								
B \ A	9.7m		16.8m		24.4m		31.0m	
	C		C		C		C	
3.0	60.6	30.0	74.4	19.2	79.7	12.5		
3.5	57.0	27.2	72.5	19.2	78.5	12.5		
4.0	53.1	23.4	70.9	19.2	77.5	12.5	80.8	8.4
4.5	49.2	21.3	68.9	18.3	76.3	12.5	80.0	8.4
5.0	44.7	19.6	67.1	17.0	75.0	12.5	79.1	8.4
5.5	40.3	18.1	65.1	15.8	74.0	12.5	78.3	8.4
6.0	34.9	16.6	63.3	14.7	72.8	12.5	77.3	8.4
6.5	28.7	15.2	61.4	13.6	71.5	11.7	76.6	8.4
7.0	18.3	14.1	59.4	12.9	70.3	11.0	75.6	8.1
8.0			54.9	10.9	67.7	9.75	73.7	7.5
9.0			50.5	9.0	65.0	8.75	71.8	6.8
10.0			45.8	7.05	62.4	7.9	69.8	6.2
11.0			40.3	5.8	59.5	6.6	67.6	5.8
12.0			34.3	4.8	56.5	5.6	65.6	5.4
13.0			27.0	4.05	53.6	4.75	63.5	5.0
14.0			15.7	3.4	50.4	4.15	61.3	4.4
15.0					47.0	3.6	59.0	3.85
16.0					43.4	3.2	56.6	3.45
17.0					39.6	2.75	54.2	3.05
18.0					35.5	2.45	51.8	2.65
19.0					30.7	2.05	49.2	2.4
20.0					25.6	1.8	46.6	2.1
22.0							40.8	1.7
24.0							34.4	1.3
26.0							26.2	1.0
28.0							13.4	0.5
<b>D</b>	0°							

Unit: x1000kg

LIFTING CAPACITIES AT ZERO DEGREE BOOM ANGLE								
ON OUTRIGGERS FULLY EXTENDED 6.3m SPREAD 360° ROTATION								
C \ A	9.7m		16.8m		24.4m		31.0m	
	B		B		B		B	
0°	7.2	13.4	14.3	3.2	21.9	1.2	28.5	0.5

**A** : Boom length (m)

**B** : Load radius (m)

**C** : Loaded boom angle (°)

**D** : Minimum boom angle (°) for indicated length (no load)

Unit: x1000kg

ON OUTRIGGERS MID EXTENDED 5.9m SPREAD								
360° ROTATION								
B \ A	9.7m		16.8m		24.4m		31.0m	
	C		C		C		C	
3.0	60.6	30.0	74.4	19.2	79.7	12.5		
3.5	57.0	27.2	72.5	19.2	78.5	12.5		
4.0	53.1	23.4	70.9	19.2	77.5	12.5	80.8	8.4
4.5	49.2	21.3	68.9	18.3	76.3	12.5	80.0	8.4
5.0	44.7	19.6	67.1	17.0	75.0	12.5	79.1	8.4
5.5	40.3	18.1	65.1	15.8	74.0	12.5	78.3	8.4
6.0	34.9	16.6	63.3	14.7	72.8	12.5	77.3	8.4
6.5	28.7	15.2	61.4	13.6	71.5	11.7	76.6	8.4
7.0	18.3	12.9	59.4	12.6	70.3	11.0	75.6	8.1
8.0			54.9	9.65	67.7	9.75	73.7	7.5
9.0			50.5	7.7	65.0	8.75	71.8	6.8
10.0			45.8	6.25	62.1	7.05	69.8	6.2
11.0			40.3	5.15	59.4	5.95	67.6	5.8
12.0			34.3	4.2	56.5	4.95	65.5	5.3
13.0			27.0	3.5	53.4	4.2	63.2	4.5
14.0			15.7	2.9	50.2	3.55	61.1	3.85
15.0					46.9	3.05	58.8	3.35
16.0					43.3	2.6	56.5	2.85
17.0					39.5	2.25	54.0	2.5
18.0					35.2	1.85	51.6	2.2
19.0					30.6	1.6	49.1	1.85
20.0					25.1	1.35	46.4	1.6
22.0							40.4	1.15
24.0							33.6	0.8
26.0							25.6	0.55
D	0°							

Unit: x1000kg

LIFTING CAPACITIES AT ZERO DEGREE BOOM ANGLE								
ON OUTRIGGERS MID EXTENDED 5.9m SPREAD 360° ROTATION								
C \ A	9.7m		16.8m		24.4m		31.0m	
	B		B		B		B	
0°	7.2	12.0	14.3	2.7	21.9	0.9	28.5	0.3

A : Boom length (m)

B : Load radius (m)

C : Loaded boom angle (°)

D : Minimum boom angle (°) for indicated length (no load)



Unit: x1000kg

ON OUTRIGGERS MID EXTENDED 5.0m SPREAD									
360° ROTATION									
B \ A	9.7m		16.8m		24.4m		31.0m		
	C		C		C		C		
3.0	60.6	30.0	74.4	19.2	79.7	12.5			
3.5	57.0	27.2	72.5	19.2	78.5	12.5			
4.0	53.1	23.4	70.9	19.2	77.5	12.5	80.8	8.4	
4.5	49.2	21.3	68.9	18.3	76.3	12.5	80.0	8.4	
5.0	44.7	19.6	67.1	17.0	75.0	12.5	79.1	8.4	
5.5	40.3	15.7	65.1	15.0	74.0	12.5	78.3	8.4	
6.0	34.9	13.2	63.3	12.65	72.8	12.5	77.3	8.4	
6.5	28.7	11.3	61.4	10.85	71.5	11.7	76.6	8.4	
7.0	18.2	9.65	59.4	9.5	70.1	10.4	75.6	8.1	
8.0			54.9	7.3	67.5	8.2	73.7	7.5	
9.0			50.5	5.8	64.8	6.7	71.8	6.8	
10.0			45.8	4.7	62.0	5.5	69.5	5.8	
11.0			40.3	3.8	59.3	4.65	67.3	4.9	
12.0			34.3	3.1	56.3	3.9	65.2	4.25	
13.0			27.0	2.55	53.0	3.25	63.0	3.6	
14.0			15.7	1.9	49.9	2.75	60.8	3.1	
15.0					46.6	2.3	58.5	2.65	
16.0					43.0	1.9	56.1	2.25	
17.0					39.4	1.6	53.8	1.95	
18.0					35.2	1.35	51.3	1.65	
19.0					30.5	1.1	48.7	1.4	
20.0					24.9	0.75	46.0	1.2	
22.0							40.3	0.8	
D	0°						26°		

Unit: x1000kg

LIFTING CAPACITIES AT ZERO DEGREE BOOM ANGLE								
ON OUTRIGGERS MID EXTENDED 5.0m SPREAD 360° ROTATION								
C \ A	9.7m		16.8m		24.4m			
	B		B		B			
0°	7.2	9.0	14.3	1.8	21.9	0.5		

- A : Boom length (m)
- B : Load radius (m)
- C : Loaded boom angle (°)
- D : Minimum boom angle (°) for indicated length (no load)

Unit: x1000kg

ON OUTRIGGERS MIN EXTENDED 2.2m SPREAD								
360° ROTATION								
B \ A	9.7m		16.8m		24.4m		31.0m	
	C		C		C		C	
3.0	60.6	13.2	74.2	13.0	79.5	12.5		
3.5	57.0	10.25	72.2	9.8	78.4	10.9		
4.0	53.1	8.0	70.5	7.8	77.2	8.8	79.9	8.0
4.5	49.2	6.7	68.4	6.45	75.9	7.25	79.0	7.2
5.0	44.7	5.7	66.8	5.3	74.6	6.2	77.9	6.05
5.5	40.3	4.7	64.6	4.4	73.3	5.2	77.0	5.45
6.0	34.9	3.85	62.8	3.65	72.0	4.4	76.1	4.8
6.5	28.7	3.3	60.9	3.05	70.6	3.8	75.1	4.25
7.0	18.3	2.7	58.7	2.6	69.5	3.3	74.1	3.65
8.0			54.6	1.85	66.7	2.4	72.3	2.75
9.0			50.2	1.2	64.1	1.75	70.3	2.05
10.0			45.1	0.55	61.3	1.35	68.3	1.5
11.0					58.7	0.95	66.2	1.2
12.0					55.9	0.55	64.3	0.9
13.0							62.2	0.5
<b>D</b>	0°		40°		53°		60°	

Unit: x1000kg

LIFTING CAPACITIES AT ZERO DEGREE BOOM ANGLE								
ON OUTRIGGERS MIN EXTENDED 2.2m SPREAD 360° ROTATION								
C \ A	9.7m							
	B							
0°	7.2	2.5						

**A** : Boom length (m)

**B** : Load radius (m)

**C** : Loaded boom angle (°)

**D** : Minimum boom angle (°) for indicated length (no load)

NOTES FOR "ON OUTRIGGERS" TABLE

1. Rated lifting capacities shown in the table are based on condition that crane is set on firm level surface. Those above bold lines are based on crane strength and those below, on its stability.
2. Rated lifting capacities based on crane stability are according to ISO 4305.
3. The mass of the hook (270kg for 30 t capacity, 100kg for 3.9 t capacity), slings and all similarly used load handling devices must be considered as part of the load and must be deducted from the lifting capacities.
4. For rated lifting capacity of single top, reduce the rated lifting capacities of relevant boom according to a weight reduction for auxiliary load handling equipment. Capacities of single top shall not exceed 3,900 kg including main boom hook mass and the net capacity must be so reduced.
5. Standard number of parts of line for each boom length is as shown below. Load per line should not surpass 38.2 kN {3,900 kgf} for main winch.

Boom length	9.7m	9.7m to 16.8m	16.8m to 31.0m	Single top
Number of parts of line	9	6	4	1

The lifting capacity data stored in the AUTOMATIC MOMENT LIMITER (AML-L) is based on the standard number of parts of line listed in the chart.

Maximum lifting capacity is restricted by the number of parts of line of AUTOMATIC MOMENT LIMITER (AML-L).

6. The lifting capacity for over-side area differs depending on the outrigger extension width. Work with the capacity corresponding to the extension width. The lifting capacities for over-front and over-rear areas are for "outriggers fully extended". However, the areas (angle  $a$ ) differ depending on the outrigger extension width.

Outriggers extended width	5.9m (middle)	5.0m (middle)	2.2m (minimum)
Angle $a^\circ$	45	40	15

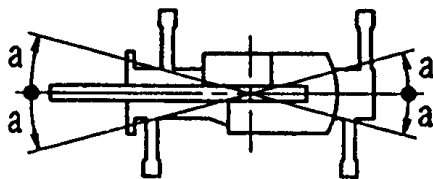

## RATED LIFTING CAPACITIES

ISO 4305

Unit: x1000kg

ON RUBBER STATIONARY													
B	A	Over Front						360° Rotation					
		9.7m		16.8m		24.4m		9.7m		16.8m		24.4m	
		C		C		C		C		C		C	
3.0		60.6	18.0					60.6	11.0				
3.5		56.8	17.0					57.1	9.0				
4.0		53.0	15.0					53.5	7.3				
4.5		49.2	12.7	68.8	11.0			49.7	5.7	68.5	5.5		
5.0		44.9	10.6	66.9	9.5			45.4	4.9	66.3	4.5		
5.5		39.9	9.0	64.9	8.0			40.8	4.0	64.6	3.7		
6.0		34.6	7.7	63.1	7.0			35.3	3.2	62.5	3.1		
6.5		27.7	6.6	61.1	6.1			28.9	2.75	60.9	2.5		
7.0		17.7	5.7	59.0	5.3			20.5	2.27	58.6	2.1		
8.0				54.6	4.25	67.2	5.0			54.6	1.4	66.9	2.2
9.0				50.0	3.45	64.3	3.9			49.9	0.85	64.3	1.6
10.0				45.2	2.65	61.6	3.15					61.6	1.1
11.0				40.1	2.1	58.8	2.55					58.7	0.8
12.0				33.8	1.6	55.9	2.1						
13.0				26.5	1.2	52.9	1.75						
14.0				15.7	0.75	49.7	1.4						
15.0						46.7	1.1						
16.0						43.1	0.85						
17.0						39.4	0.6						
<b>D</b>		0°			28°			0°		44°		56°	

Unit: x1000kg

LIFTING CAPACITY AT ZERO DEGREE BOOM ANGLE ON RUBBER STATIONARY													
C	A	Over Front						360° Rotation					
		9.7m		16.8m				9.7m					
		B		B				B					
0°		7.2	5.4	14.3	0.7			7.2	2.1				

**A** : Boom length (m)

**B** : Load radius (m)

**C** : Loaded boom angle (°)

**D** : Minimum boom angle (°) for indicated length (no load)

Unit: x1000kg

ON RUBBER CREEP												
B \ A	Over Front						360° Rotation					
	9.7m		16.8m		24.4m		9.7m		16.8m		24.4m	
	C		C		C		C		C		C	
3.0	60.6	18.0					60.6	10.0				
3.5	56.8	15.45					57.0	8.0				
4.0	53.0	13.0					53.3	6.5				
4.5	49.0	11.1	68.6	9.7			49.2	5.1	68.6	5.1		
5.0	44.7	9.3	66.6	8.4			44.4	4.3	66.6	4.2		
5.5	39.8	7.95	64.6	7.0			39.6	3.7	64.7	3.5		
6.0	34.7	6.7	62.8	6.0			34.0	3.0	62.7	2.7		
6.5	28.0	5.75	60.8	5.3			27.0	2.5	60.7	2.35		
7.0	18.2	5.0	58.7	4.65			18.1	1.95	58.9	1.85		
8.0			54.4	3.6	67.0	4.3			54.5	1.3	67.0	1.9
9.0			49.9	2.8	64.3	3.4			50.2	0.75	64.3	1.35
10.0			45.1	2.3	61.7	2.8					61.7	0.9
11.0			39.6	1.8	58.8	2.25					58.8	0.6
12.0			33.3	1.35	56.0	1.8						
13.0			26.0	1.0	52.9	1.5						
14.0			14.6	0.6	49.7	1.2						
15.0					46.4	0.95						
16.0					42.9	0.6						
D	0°				31°		0°		44°		56°	

Unit: x1000kg

LIFTING CAPACITY AT ZERO DEGREE BOOM ANGLE ON RUBBER CREEP												
C \ A	Over Front						360° Rotation					
	9.7m		16.8m				9.7m					
	B		B				B					
0°	7.2	4.7	14.3	0.5			7.2	1.8				

A :Boom length (m)

B :Load radius (m)

C :Loaded boom angle (°)

D :Minimum boom angle (°) for indicated length (no load)

NOTES FOR "ON RUBBER" TABLES

1. Rated lifting capacities shown in the table are based on condition that crane is set on firm level surface, with suspension lock applied. Those above bold lines are based on tire capacity and those below, on crane stability. They are based on actual working radii increased by tire deformation and boom deflection.
2. Rated lifting capacities based on crane stability are according to ISO 4305.
3. The mass of the hook (270 kg for 30 t capacity, 100 kg for 3.9 t capacity), slings and all similarly used load handling devices must be considered as part of the load and must be deducted from the lifting capacities.
4. For rated lifting capacity of single top, reduce the rated lifting capacities of relevant boom according to a weight reductions for auxiliary load handling equipment. Capacities of single top shall not exceed 3,900 kg including main hook.
5. Maximum permissible boom length is 24.4 m.
6. CREEP is motion for crane not to travel more than 60 m in any 30 minute period and to travel at the speed of less than 1.6 km/h.
7. During "CREEP" duties travel slowly and keep the lifting load as close to the ground as possible, and especially avoid any abrupt steering, accelerating or braking.
8. Do not operate the crane while carrying the load.
9. Tires should be inflated to their correct air pressure of 0.9 MPa {9.0 kgf/cm<sup>2</sup>}.
10. For CREEP operation, set Drive select switch to "4-WHEEL(Lo)" and set gear shift lever to "1".
11. Standard number of parts of line for on tires operation should be according to the following table.

Load per line should not surpass 38.2 kN {3,900 kgf} for main winch.

Boom length	Over Front			360° Rotation		
	9.7m	16.8m	24.4m	9.7m	16.8m	24.4m
Number of parts of line (Single top)	6 (1)	4 (1)	4 (1)	4 (1)	4 (1)	4 (1)

The lifting capacity data stored in the AUTOMATIC MOMENT LIMITER (AML-L) is based on the standard number of parts of line listed in the chart.

Maximum lifting capacity is restricted by the number of parts of line of AUTOMATIC MOMENT LIMITER (AML-L).

WORKING AREA

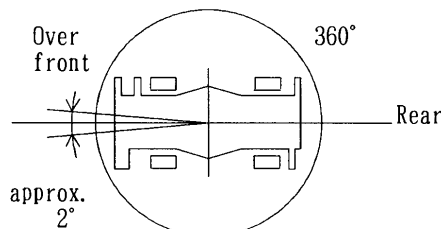

Without outriggers "Over front" operation should be performed within 2 degrees in front of chassis.

## WORKING RANGE

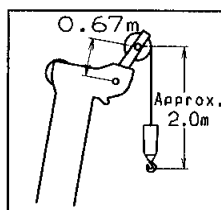
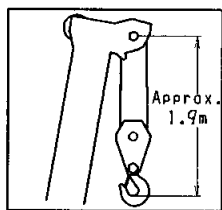
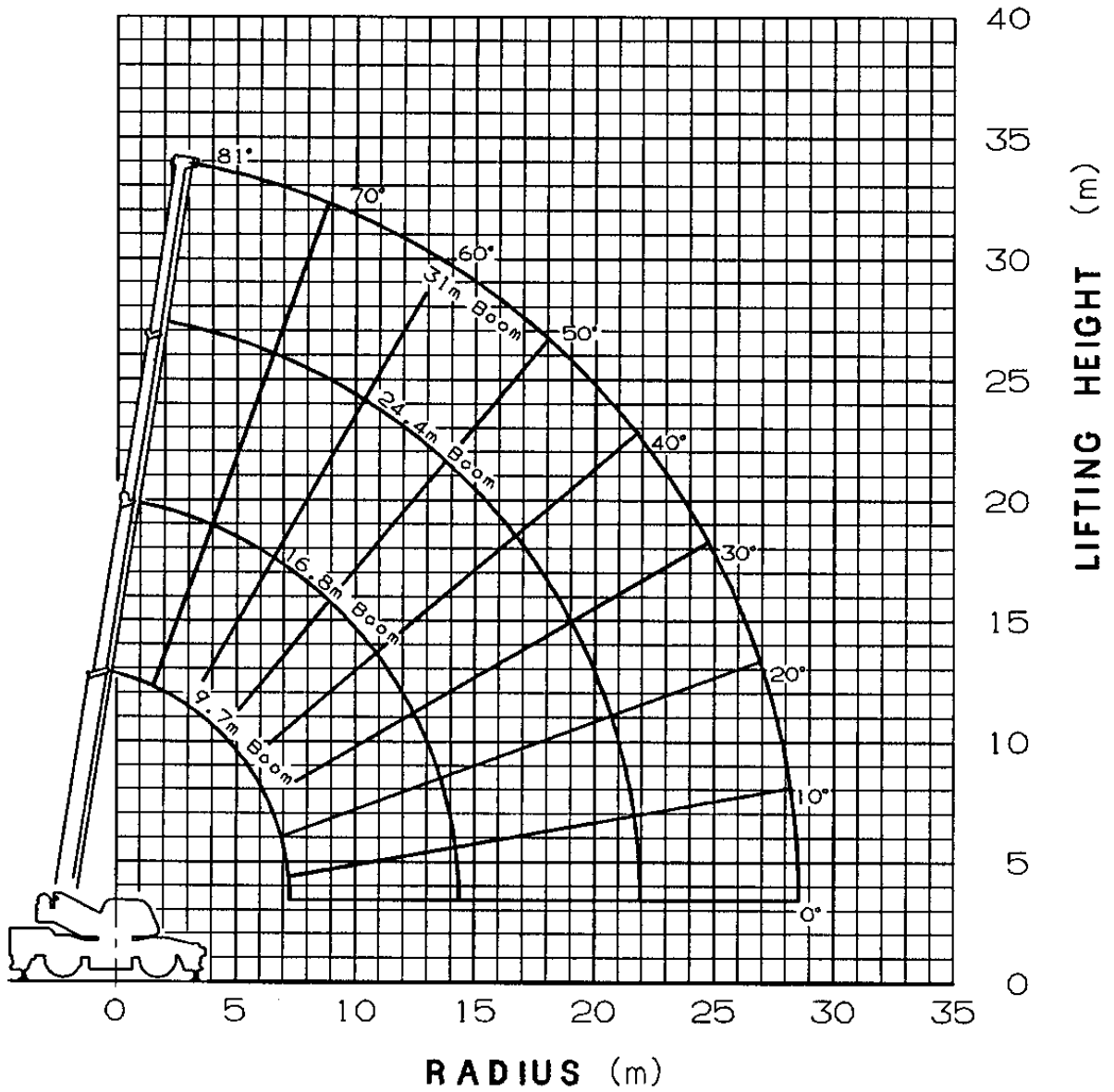

Boom Length

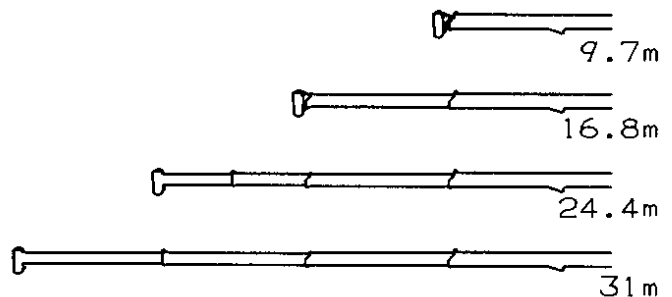

NOTE: The above lifting height and boom angle are based on a straight (unladen) boom, and allowance should be made for boom deflection obtained under laden conditions.  
 The above working range is shown on condition with outriggers fully(6.3m) extended.

# DIMENSIONS

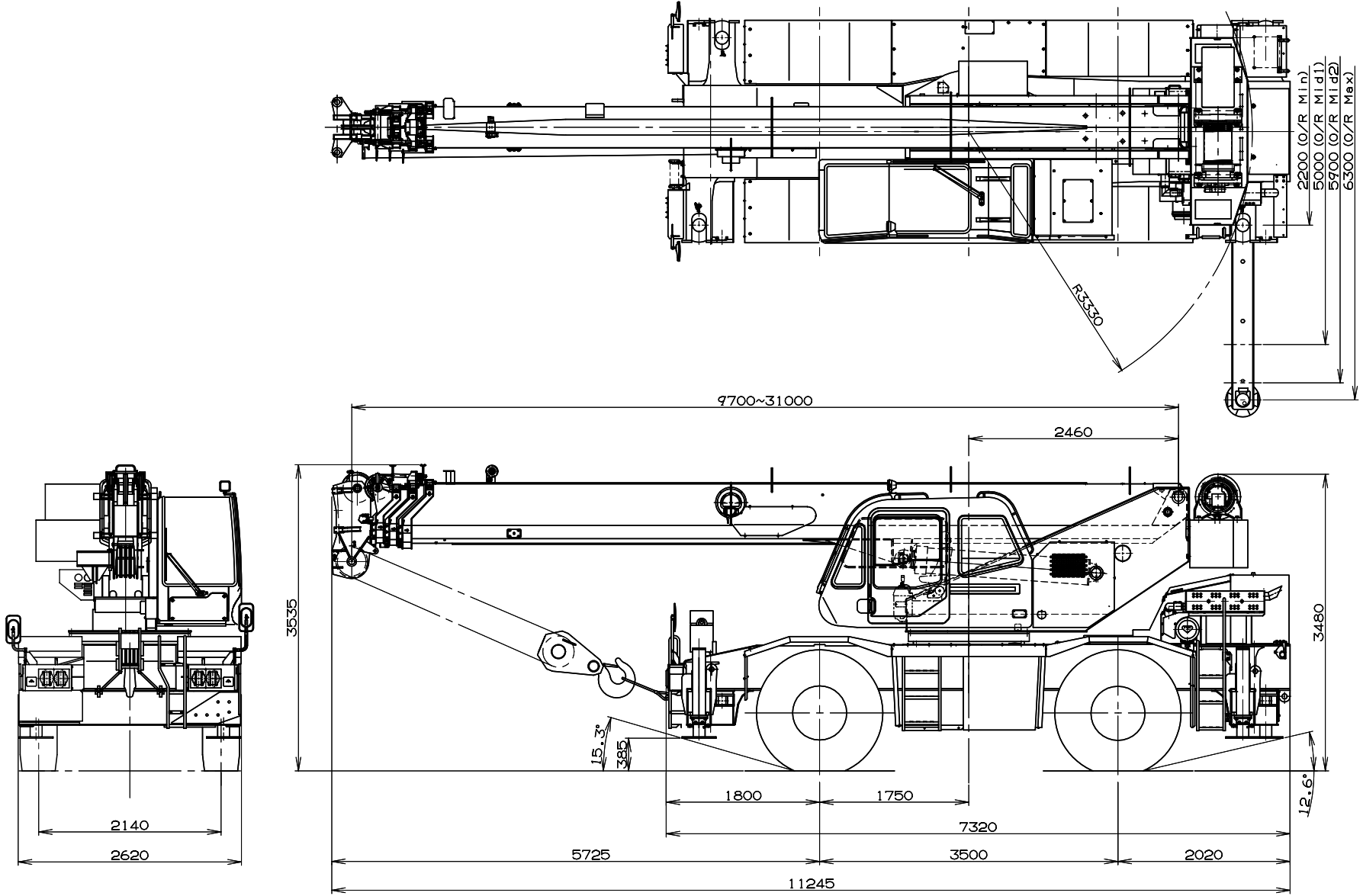



## GR-300EX Axle Weight Distribution Chart

UNIT : kg

	GVW	Front	Rear
Basic standard machine includes: 4-section boom (9.7 m - 31.0 m) Cummins QSB6.7 445 / 95 R 25 tires Single top 3.9 ton hook ball	26,370	12,420	13,950
Add: 1. Hot water cab heater, air conditioner and defroster	+95	+26	+69
Remove: 1. 30 ton 4 sheaves hook block 2. 3.9 ton hook ball	-270 -100	-480 -140	+210 +40