



# GR-1200XL

(Left-hand drive)

110 Metric Ton (120 US Ton) Capacity

SPEC. SHEET NO. GR-1200-3-00104/ES-02

## HYDRAULIC ROUGH TERRAIN CRANE

### DIMENSIONS

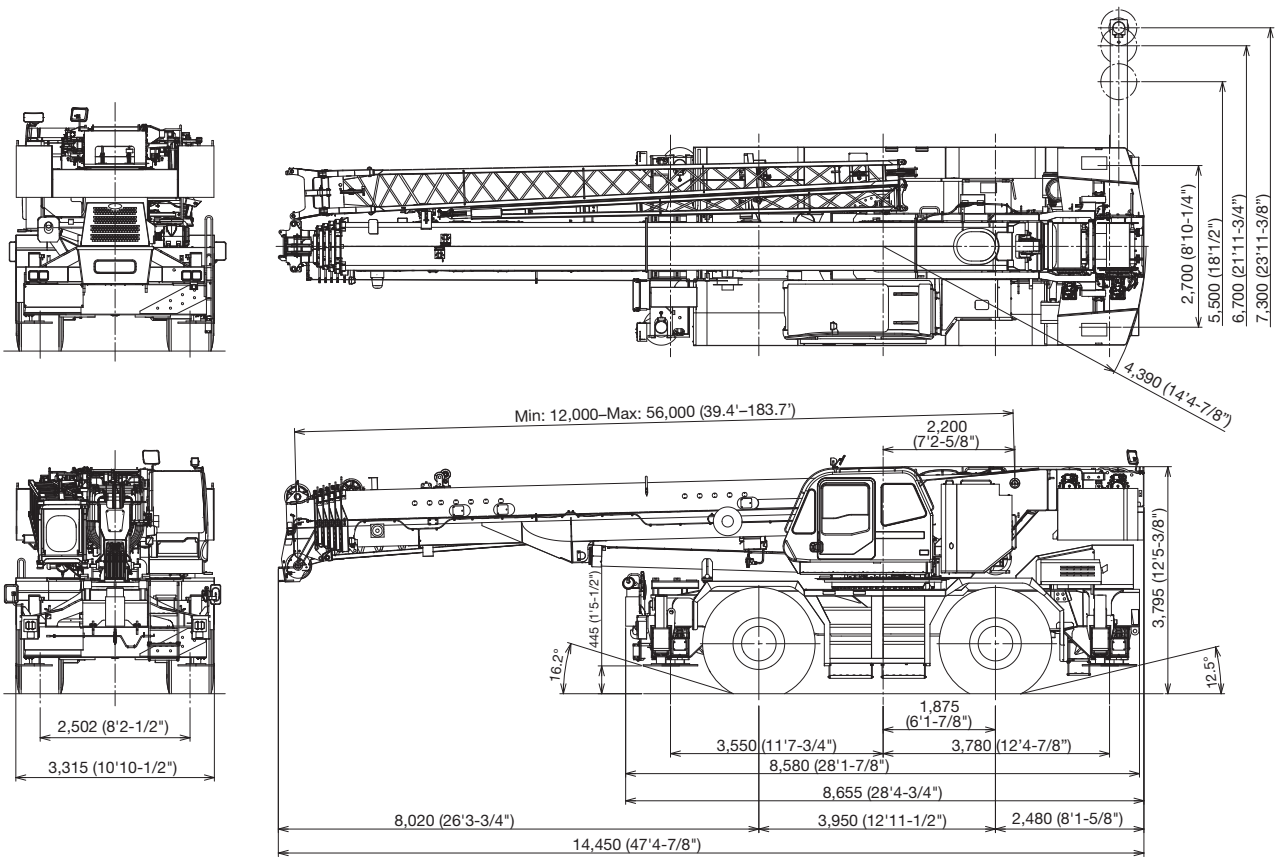

Note: Dimension is with boom angle at -1.5 degree.  
( ) Reference dimensions in feet.

### GENERAL DIMENSIONS

|                                    | Meter | Feet   |
|------------------------------------|-------|--------|
| Turning radius (29.5–25 34PR (OR)) |       |        |
| 4 wheel steer                      | 6.8   | 22' 4" |
| 2 wheel steer                      | 11.9  | 39' 1" |

|                              | Meter          | Feet        |
|------------------------------|----------------|-------------|
| Overall length               | approx. 14,450 | 47' 4-7/8"  |
| Overall width                | approx. 3,315  | 10' 10-1/2" |
| Overall height               | approx. 3,795  | 12' 5"-3/8" |
| Carrier length for traveling | approx. 8,580  | 28' 1-7/8"  |

# CRANE SPECIFICATIONS

## BOOM

6 sections boom of round box construction with 5 sheaves at boom head, extended by single telescoping cylinder.  
2 easily removable wire rope guards, rope dead end provided on both sides of boom head. Boom telescope sections are supported by wear pads both vertically and horizontally.

Fully retracted length..... 12.0 m (39.4')  
Fully extended length..... 56.0 m (183.7')  
Extension speed..... 44.0 m (144.3') in 340 s  
Sheave root diameter..... 0.400 m (15-3/4")

## BOOM ELEVATION

By a double acting hydraulic cylinder with holding valve.  
Boom angle indicator.

Automatic speed reduction and slow stop function.  
Boom angle ..... -1.5–81°  
Boom raising speed ..... 20° to 60° in 40 s

## JIB

2 stage bi-fold lattice type, 3.5°, 25° or 45° offset.  
Single sheave at the head of both jib sections. Stowed alongside base boom section. Assistant cylinders for mounting and stowing, controlled at right side of superstructure.  
Self stowing jib mounting pins.

Length ..... 10.1 m, 17.7 m (33.2', 58.1')  
Offset..... 3.5°, 25°, 45°  
Sheave root diameter..... 0.396 m (15-5/8")

## AUXILIARY LIFTING SHEAVE (SINGLE TOP)

Single sheave, mounted to main boom head for single line work (stowable).

Root diameter..... 0.440 m (17-5/16")

## ANTI-TWO BLOCK DEVICE

Pendant type over-winding cut out device with audio-visual (FAILURE lamp/BUZZER) warning system.

## SLEWING

Hydraulic axial piston motor driven through planetary slewing speed reducer. Continuous 360° full circle slewing on ball bearing turn table at 1.5 min<sup>-1</sup>{rpm}. Equipped with manually locked/released slewing brake. A positive swing lock manually engaged in cab. Twin slewing system: Free slewing or lock slewing controlled by selector switch on front console.

Slewing speed ..... 1.5 min<sup>-1</sup> {rpm}

## COUNTERWEIGHT

Standard weight ..... 10,000 kg (22,000 lbs)

## WINCH

### MAIN WINCH

Variable speed type with grooved drum driven by hydraulic axial piston motor through speed reducer. Power load lowering and raising. Equipped with automatic brake (neutral brake) and counterbalance valve. Controlled independently of auxiliary winch. Equipped with cable follower and drum rotation indicator.

### MAIN DRUM

Root diameter x wide ..... 0.382 m (15") x 0.742 m (29-1/4")  
Wire rope diameter x length ..... 19 mm (3/4") x 300 m (984')  
Drum capacity ..... 394 m (1293'), 7 layers  
Maximum single line pull (1st layer)..... 9,900 kg (21,800 lbs)  
Maximum permissible linepull wire strength... 7,200 kg (15,900 lbs)

### AUXILIARY WINCH

Variable speed type with grooved drum driven by hydraulic axial piston motor through speed reducer.  
Power load lowering and raising. Equipped with automatic brake (neutral brake) and counterbalance valve. Controlled independently of main winch. Equipped with cable follower and drum rotation indicator.

## AUXILIARY DRUM

Root diameter x wide ..... 0.382 m (15") x 0.742 m (29-1/4")  
Wire rope diameter x length ..... 19 mm (3/4") x 158 m (518')  
Drum capacity ..... 394 m (1293'), 7 layers  
Maximum single line pull (1st layer)..... 9,900 kg (21,800 lbs)  
Maximum permissible linepull wire strength... 7,200 kg (15,900 lbs)

## WIRE ROPE

Non-rotating 19 mm (3/4") 7x35 class.  
Breaking Strength 36,000 kg (79,400 lbs)

## HOOK BLOCKS

110 metric ton (120 ton, option).. 8 sheaves with hook block and safety latch.  
70 metric ton (77 ton, option)..... 5 sheaves with hook block and safety latch.  
45 metric ton (50 ton, option).... 3 sheaves with hook block and safety latch.  
7.2 metric ton (9.9 ton) ..... Weighted hook with swivel and safety latch.

## HYDRAULIC SYSTEM

### PUMPS

2 variable piston pumps for crane functions.  
Tandem gear pump for steering, swing and optional equipment.  
Powered by carrier engine. Pump disconnect for crane is engaged/ disengaged by rotary switch from operator's cab.

### CONTROL VALVES

Multiple valves actuated by pilot pressure with integral pressure relief valves.

### RESERVOIR

763 lit. (202 gallon) capacity. External sight level gauge.

### FILTRATION

BETA10=10 return filter, full flow with bypass protection, located inside of hydraulic reservoir. Accessible for easy replacement.

### OIL COOLER

Air cooled fan type.

## CAB AND CONTROLS

Both crane and drive operations can be performed from one cab mounted on rotating superstructure.

15° tilt, Left side, 1 man type, steel construction with sliding door access and safety glass windows opening at side. Door window is powered control. Windshield glass window and roof glass window are shatter-resistant. Tilt-telescoping steering wheel. Adjustable control lever stands for swing, boom elevating, boom telescoping, auxiliary winch and main winch. Control lever stands can change neutral positions and tilt for easy access to cab. 3 way adjustable operator's seat with high back, headrest and armrest. Engine throttle knob. Foot operated controls: boom elevating boom telescoping, service brake and engine throttle. Hot water cab heater and air conditioning.

Dash-mounted engine start/stop, monitor lamps, cigarette lighter, drive selector switch, parking brake switch, steering mode select switch, power window switch, pump engaged/ disengaged switch, swing brake switch, telescoping/auxiliary winch select switch, outrigger controls, free swing / lock swing selector switch, eco mode switch, high speed winch (main/aux) switch and ashtray.

Instruments - Torque converter oil temperature, engine water temperature, air pressure, fuel, speedometer, tachometer, hour meter and odometer / tripmeter. Hydraulic oil pressure is monitored and displayed on the AML-C display panel.

# CRANE SPECIFICATIONS

Tadano electronic LOAD MOMENT INDICATOR system (AML-C) including:

- Control lever lockout function with audible and visual pre-warning
- Boom position indicator
- Outrigger state indicator
- Boom angle / boom length / jib offset angle / jib length / load radius / rated lifting capacities / actual loads read out
- Ratio of actual load moment to rated load moment indication
- Automatic speed reduction and slow stop function on boom elevation and slewing
- Working condition register switch
- Load radius / boom angle / tip height / slewing range preset function
- External warning lamp
- Tare function
- Fuel consumption monitor
- Main winch / auxiliary winch select
- Drum rotation indicator (audible and visible type) main and auxiliary winch

TADANO AML-C monitors outrigger extended length and automatically programs the corresponding "RATED LIFTING CAPACITIES" table.

Operator's right hand console includes transmission gear selector and sight level bubble. Upper console includes working light switch, roof washer and wiper switch emergency outrigger set up key switch, jib equipped/removed select switch, eco mode switch, high speed winch (main / aux) switch, Cab tilt switch. Slewing lock lever.

NOTE: Each crane motion speed is based on unladen conditions.

# CARRIER SPECIFICATIONS

## TYPE

Rear engine, left hand steering, driving axle 2-way selected type by manual switch, 4x2 front drive, 4x4 front and rear drive.

## FRAME

High tensile steel, all welded mono-box construction.

## ENGINE

|                              |  |
|------------------------------|--|
| Model                        | MITSUBISHI 6M60-TLU3R<br>[ECE-R96-02]      |
| Type                         | Direct injection diesel                    |
| No. of cylinders             | 6  |
| Combustion                   | 4 cycle, turbo charged and after cooled    |
| Bore x Stroke, mm (in)       | 118 x 115 (4.646 x 4.528)                  |
| Displacement, liters (cu.in) | 7.54 (460)                                 |
| Air inlet heater             | 24 volt preheat                            |
| Air cleaner                  | Dry type, replaceable element              |
| Oil filter                   | Full flow with replaceable element         |
| Fuel filter                  | Full flow with replaceable element         |
| Fuel tank, liters (gal)      | 300 (79.2), right side of carrier          |
| Cooling                      | Liquid pressurized, recirculating by-pass  |
| Radiator                     | Fin and tube core, thermostat controlled   |
| Fan, mm (in)                 | Suction type, 6-blade, 600 (23.6) dia.     |
| Starting                     | 24 volt                                    |
| Charging                     | 24 volt system, negative ground            |
| Battery                      | 2-120 amp. Hour                            |
| Compressor, air, l/min (CFM) | 830 (29) at 2,600 min <sup>-1</sup>        |
| Output, Max. kW (HP)         | Gross 200 (267) at 2,600 min <sup>-1</sup> |
| Torque, Max. N•m (ft-lb)     | 785 (579) at 1,400 min <sup>-1</sup>       |
| Capacity, liters (gal)       |  |
| Cooling water                | 13 (3.4)                                   |
| Lubrication                  | 13-15 (3.4-4.0)                            |
| Fuel                         | 300 (79.2)                                 |

## TRANSMISSION

Electronically controlled full automatic transmission. Torque converter driving full powershift with driving axle selector. 5 forward and 2 reverse speeds, constant mesh.

- 2 speeds - high range - 2 wheel drive; 4 wheel drive
- 3 speeds - low range - 4 wheel drive

## TRAVEL SPEED

12 mph (19 km/h)

**GRADE ABILITY (tanθ)** - 84% (at stall), 30%\*

\* Machine should be operated within the limit of engine crankcase design (17°: MITSUBISHI 6M60-TLU3R)

## AXLE

Front: Full floating type, steering and driving axle with planetary reduction.

Rear: Full floating type, steering and driving axle with planetary reduction and non-spin rear differential.

## STEERING

Hydraulic power steering controlled by steering wheel. Four steering modes available: 2 wheel front, 2 wheel rear, 4 wheel coordinated and 4 wheel crab.

## SUSPENSION

Front: Rigid mounted to frame.

Rear: Pivot mounted with hydraulic lockout device.

## BRAKE SYSTEMS

Service: Air over hydraulic disc brakes on all 4 wheels.

Parking/Emergency: Spring applied-air released brake acting on input shaft of front axle.

Auxiliary: Electro- pneumatic operated exhaust brake.

**TIRES** - 29.5-25 34PR (OR) Air pressure: 400 kPa (57 psi)

## OUTRIGGERS

Four hydraulic, beam and jack outriggers. Vertical jack cylinders equipped with integral holding valve. Each outrigger beam and jack is controlled independently from cab. Beams extend to 7.3 m (23' 11-3/8") center-line and retract to within 3.315 m (10' 10-1 / 2") overall width with floats. Outrigger jack floats are attached thus eliminating the need of manually attaching and detaching them. Controls and sight bubble located in superstructure cab. Four outrigger extension lengths are provided with corresponding "RATED LIFTING CAPACITIES" for crane duty in confined areas.

Min. Extension 2.7 m (8' 10-1 / 4") center to center

Mid. Extension 5.5 m (18' 1 / 2") center to center

Mid. Extension 6.7 m (21' 11-3 / 4") center to center

Max. Extension 7.3 m (23' 11-3 / 8") center to center

Float size (Diameter) 0.6 m (1' 11- 5 / 8")

## STANDARD EQUIPMENT

- Telematics (machine data logging and monitoring system) with - HELLO-NET via internet (availability depends on countries)
- Eco mode system
- Positive control
- Over unwinding prevention
- Emergency steering system
- Transmission neutral position engine start
- Overshift prevention
- Parking braked travel warning
- Tilt-telescope steering wheel
- Halogen head lamp
- Fenders
- Air dryer
- Water separator with filter (high filtration)
- Air cleaner dust indicator
- Full instrumentation package
- Tire inflation kit
- Towing hooks-Front and rear
- Lifting eyes
- Hook block tie down (front bumper)
- Weighted hook storage compartment
- Winch drum mirror
- Tool storage compartment

## OPTIONAL EQUIPMENT

- Boom and jib mounted aircraft warning light
- Wind speed indicator
- 45 metric ton (50 ton) - 3 sheaves with hook block and safety latch
- 70 metric ton (77 ton) - 5 sheaves with hook block and safety latch
- 110 metric ton (120 ton) - 8 sheaves with hook block and safety latch
- Inclinator (electronic inclination indicator)
- Outrigger load display and warning

## HOISTING PERFORMANCE

### LINE SPEEDS AND PULLS

| Layer            | Main or auxiliary winch - 0.382 m (15") drum |       |       |       |                                   |        |
|------------------|--|-------|-------|-------|-----------------------------------|--------|
|                  | Line speeds <sup>1</sup>                     |       |       |       | Line pulls Available <sup>2</sup> |        |
|                  | Low  |       | High  |       | Low                               |        |
|                  | m/min  | F.P.M | m/min | F.P.M | kgf                               | Lbs.   |
| 1st              | 77   | 253   | 108   | 354   | 9,900                             | 21,800 |
| 2nd              | 84   | 276   | 117   | 384   | 9,010                             | 19,900 |
| 3rd              | 91   | 299   | 126   | 413   | 8,270                             | 18,200 |
| 4th              | 97   | 318   | 136   | 446   | 7,640                             | 16,800 |
| 5th              | 104  | 341   | 145   | 476   | 7,090                             | 15,600 |
| 6th              | 110  | 361   | 154   | 505   | 6,620                             | 14,600 |
| 7th <sup>3</sup> | 117  | 384   | 163   | 535   | 6,210                             | 13,700 |

- Maximum permissible line pull wire strength.  
7,200 kg (15,900 lbs) with 7 x 35 class rope.

- <sup>1</sup> Line speed based only on hook block, not loaded.  
<sup>2</sup> Developed by machinery with each layer of wire rope, but not based on rope strength or other limitations in machinery or equipment.  
<sup>3</sup> Seventh layer of wire rope are not recommended for hoisting operations.

### DRUM WIRE ROPE CAPACITIES

| Wire rope layer | Main and auxiliary drum grooved lagging |       |                 |        |
|-----------------|---|-------|-----------------|--------|
|                 | 19 mm (3/4") wire rope                  |       |                 |        |
|                 | Rope per layer                          |       | Total wire rope |        |
|                 | Meter                                   | Feet  | Meter           | Feet   |
| 1               | 44.8                                    | 147.0 | 44.8            | 147.0  |
| 2               | 48.6                                    | 159.4 | 93.4            | 306.4  |
| 3               | 52.5                                    | 172.2 | 145.9           | 478.7  |
| 4               | 56.3                                    | 184.7 | 202.2           | 663.4  |
| 5               | 60.1                                    | 197.2 | 262.3           | 860.6  |
| 6               | 63.9                                    | 209.6 | 326.2           | 1070.2 |
| 7               | 67.7                                    | 222.1 | 393.9           | 1292.3 |

### DRUM DIMENSIONS (Main and auxiliary)

|                 | mm  | Inch   |
|-----------------|-----|--------|
| Root diameter   | 382 | 15     |
| Length          | 742 | 29-1/4 |
| Flange diameter | 677 | 26-5/8 |

# GR-1200XL WORKING RANGE CHART

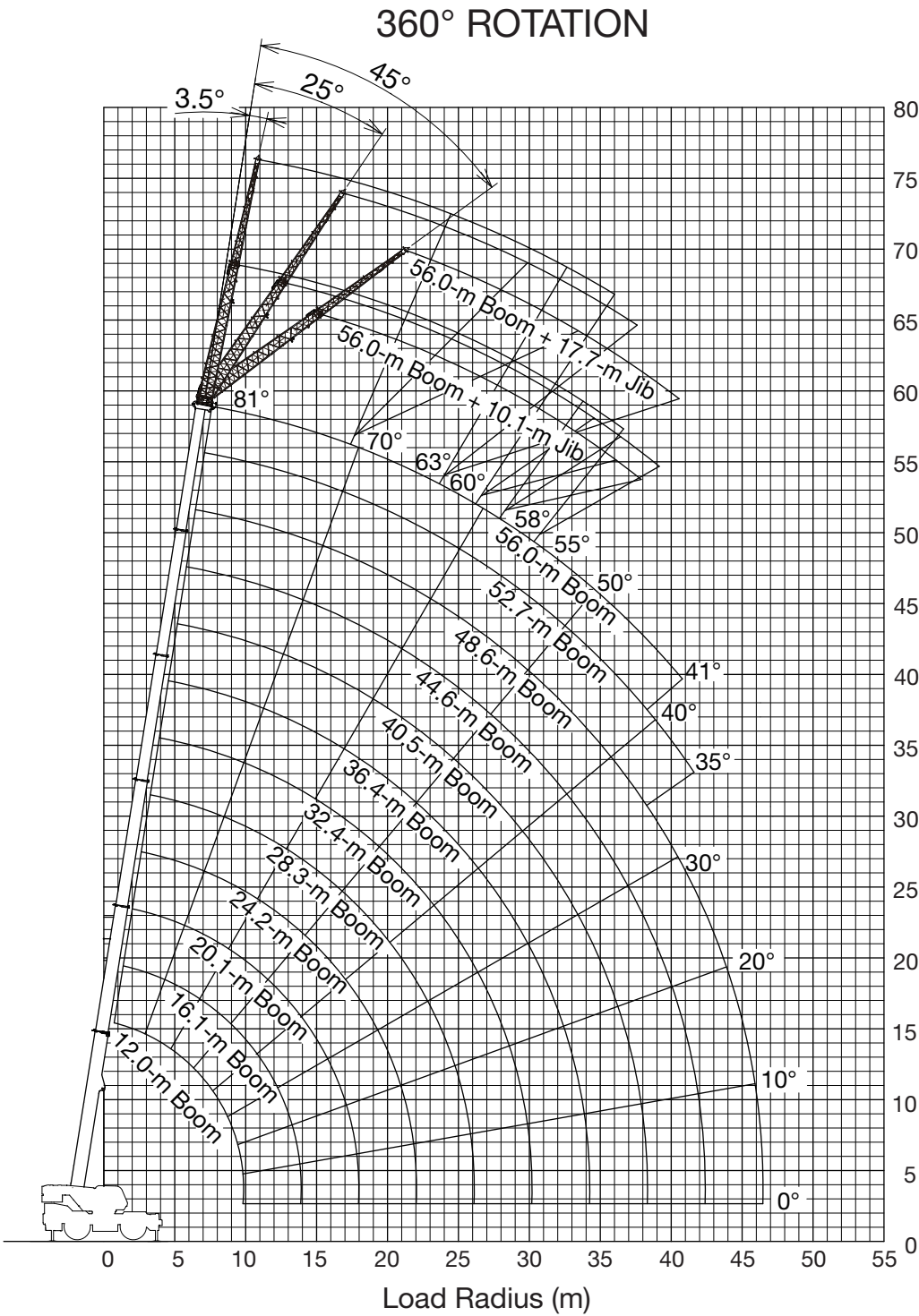

## BOOM

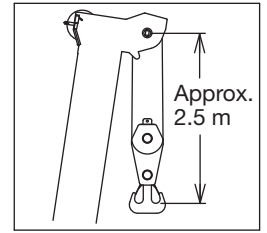

## JIB

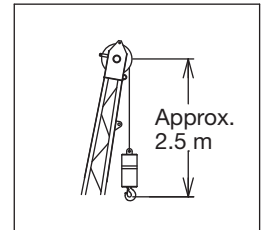

## SINGLE TOP

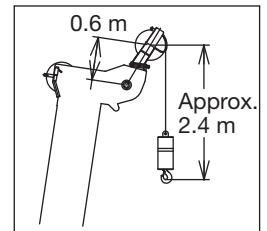

Lifting Height (m)

Load Radius (m)

NOTE: Boom and jib geometry shown are for unloaded condition and machine standing level on firm supporting surface. Boom deflection and subsequent radius and boom angle change must be accounted for when applying load to hook.

# GR-1200XL WORKING RANGE CHART

## SMART CHART

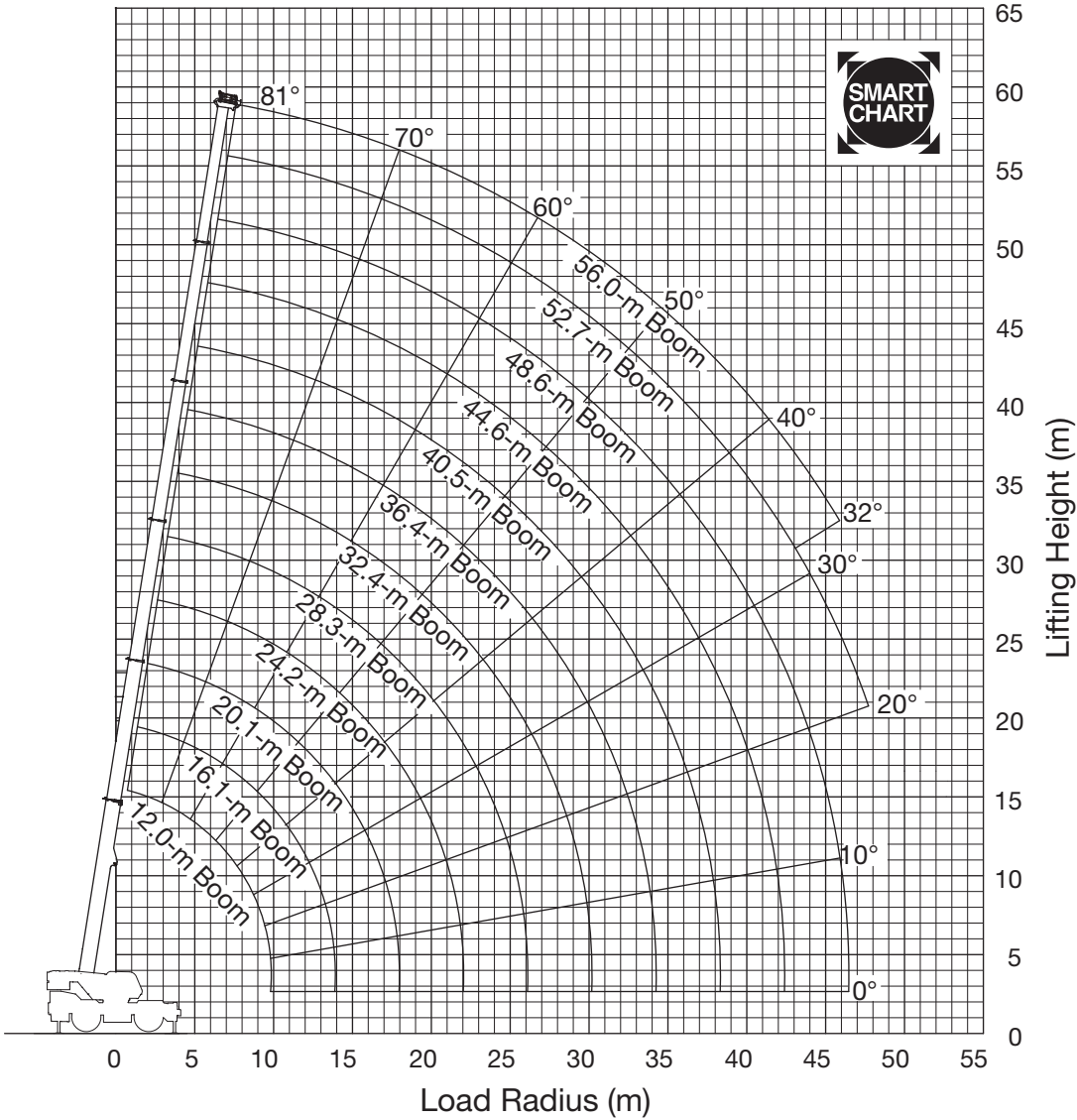

### BOOM

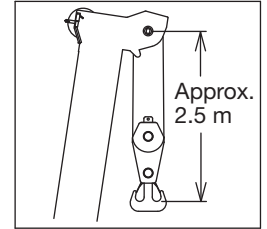

### SINGLE TOP

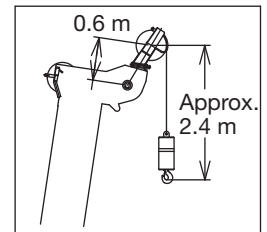

NOTE: Boom geometry shown are for unloaded condition and machine standing level on firm supporting surface. Boom deflection and subsequent radius and boom angle change must be accounted for when applying load to hook.

# GR-1200XL RATED LIFTING CAPACITIES (IN METRIC TON)

| COUNTERWEIGHT 10.0 t (22,000 lbs)<br>ON OUTRIGGERS FULLY EXTENDED 7.3 m (23'11-3/8") SPREAD<br>360° ROTATION |                   |                   |      |                   |      |      |                   |      |      |      |                   |      |      |      |
|--|-------------------|-------------------|------|-------------------|------|------|-------------------|------|------|------|-------------------|------|------|------|
| A  | 1                 | 10                | 1    | 10                | 11   | 2    | 1                 | 11   | 12   | 2    | 1                 | 12   | 2    | 1    |
| B  | 1                 | 24                | 2    | 25                | 26   | 12   | 3                 | 27   | 28   | 13   | 4                 | 29   | 14   | 5    |
| C  | 12.0 m<br>(39.4') | 16.1 m<br>(52.7') |      | 20.1 m<br>(66.1') |      |      | 24.2 m<br>(79.4') |      |      |      | 28.3 m<br>(92.8') |      |      |      |
| D  |                   |                   |      |                   |      |      |                   |      |      |      |                   |      |      |      |
| 2.50   | *110.0            | 65.0              | 35.0 |                   |      |      |                   |      |      |      |                   |      |      |      |
| 3.00   | 82.6              | 65.0              | 35.0 | 62.5              | 50.0 | 35.0 | 28.8              |      |      |      |                   |      |      |      |
| 3.50   | 74.6              | 65.0              | 35.0 | 58.8              | 50.0 | 35.0 | 26.8              |      |      | 48.2 | 35.0              | 28.2 |      |      |
| 4.00   | 67.3              | 65.0              | 34.8 | 56.0              | 50.0 | 35.0 | 25.1              | 46.7 | 48.2 | 35.0 | 26.6              |      |      |      |
| 4.50   | 61.2              | 61.0              | 32.9 | 52.7              | 50.0 | 35.0 | 23.5              | 44.4 | 48.2 | 35.0 | 25.2              | 36.6 | 31.7 | 21.9 |
| 5.00   | 55.9              | 55.7              | 31.3 | 49.7              | 50.0 | 33.8 | 22.2              | 41.8 | 48.2 | 35.0 | 23.9              | 35.5 | 31.7 | 21.1 |
| 6.00   | 46.9              | 46.5              | 28.5 | 44.6              | 46.9 | 31.1 | 19.9              | 37.5 | 47.3 | 32.6 | 21.7              | 32.8 | 31.7 | 19.4 |
| 7.00   | 39.1              | 38.8              | 26.2 | 38.5              | 39.1 | 28.9 | 18.0              | 33.9 | 39.5 | 30.5 | 19.9              | 30.0 | 30.8 | 18.0 |
| 8.00   | 33.4              | 33.0              | 24.2 | 32.8              | 33.3 | 26.9 | 16.5              | 30.9 | 33.7 | 28.6 | 18.3              | 27.3 | 29.2 | 16.7 |
| 9.00   | 28.3              | 27.7              | 22.6 | 27.4              | 28.2 | 25.3 | 15.2              | 27.8 | 28.8 | 27.0 | 17.0              | 25.1 | 27.6 | 15.5 |
| 10.00  |                   | 23.5              | 21.2 | 23.0              | 23.9 | 23.8 | 14.1              | 23.5 | 24.6 | 25.2 | 15.9              | 23.1 | 26.2 | 14.5 |
| 11.00  |                   | 19.5              | 20.1 | 19.1              | 19.9 | 22.5 | 13.1              | 19.5 | 20.5 | 22.7 | 14.9              | 20.1 | 22.5 | 13.5 |
| 12.00  |                   | 16.4              | 18.6 | 16.0              | 16.9 | 19.4 | 12.3              | 16.4 | 17.4 | 19.5 | 14.0              | 17.0 | 19.3 | 12.7 |
| 14.00  |                   |                   |      | 11.7              | 12.5 | 14.8 | 10.9              | 12.1 | 13.0 | 15.0 | 12.6              | 12.6 | 14.8 | 11.3 |
| 16.00  |                   |                   |      | 8.8               | 9.5  | 11.7 | 9.9               | 9.1  | 10.0 | 11.9 | 11.4              | 9.6  | 11.7 | 10.1 |
| 18.00  |                   |                   |      |                   |      |      |                   | 7.0  | 7.9  | 9.6  | 10.2              | 7.5  | 9.5  | 9.2  |
| 20.00  |                   |                   |      |                   |      |      |                   | 5.4  | 6.2  | 8.0  | 8.5               | 5.9  | 7.8  | 8.4  |
| 22.00  |                   |                   |      |                   |      |      |                   | 4.2  | 5.0  | 6.7  | 7.2               | 4.6  | 6.5  | 7.2  |
| 24.00  |                   |                   |      |                   |      |      |                   |      |      |      |                   | 3.6  | 5.4  | 6.2  |
| 26.00  |                   |                   |      |                   |      |      |                   |      |      |      |                   | 2.8  | 4.6  | 5.3  |
| 28.00  |                   |                   |      |                   |      |      |                   |      |      |      |                   |      |      |      |
| 30.00  |                   |                   |      |                   |      |      |                   |      |      |      |                   |      |      |      |
| 32.00  |                   |                   |      |                   |      |      |                   |      |      |      |                   |      |      |      |
| 34.00  |                   |                   |      |                   |      |      |                   |      |      |      |                   |      |      |      |
| 36.00  |                   |                   |      |                   |      |      |                   |      |      |      |                   |      |      |      |
| 38.00  |                   |                   |      |                   |      |      |                   |      |      |      |                   |      |      |      |
| 40.00  |                   |                   |      |                   |      |      |                   |      |      |      |                   |      |      |      |
| 42.00  |                   |                   |      |                   |      |      |                   |      |      |      |                   |      |      |      |
| 44.00  |                   |                   |      |                   |      |      |                   |      |      |      |                   |      |      |      |
| E  | 19.1              | 19.0              | 20.0 | 15.4              | 18.0 | 20.0 | 15.9              | 15.9 | 17.8 | 18.6 | 16.3              | 16.0 | 17.3 | 16.3 |
| F  | 0                 | 0                 | 0    | 0                 | 0    | 0    | 0                 | 0    | 0    | 0    | 0                 | 0    | 0    | 0    |
| Telescoping conditions (%)   |                   |                   |      |                   |      |      |                   |      |      |      |                   |      |      |      |
| Tele.1   | 0                 | 46                | 0    | 92                | 46   | 0    | 0                 | 92   | 46   | 0    | 0                 | 92   | 0    | 0    |
| Tele.2   | 0                 | 0                 | 0    | 0                 | 46   | 0    | 0                 | 46   | 46   | 0    | 0                 | 46   | 46   | 0    |
| Tele.3   | 0                 | 0                 | 0    | 0                 | 0    | 0    | 0                 | 0    | 46   | 46   | 0                 | 46   | 46   | 0    |
| Tele.4   | 0                 | 0                 | 0    | 0                 | 0    | 46   | 0                 | 0    | 0    | 46   | 46                | 0    | 46   | 92   |
| Tele.5   | 0                 | 0                 | 46   | 0                 | 0    | 46   | 92                | 0    | 0    | 46   | 92                | 0    | 46   | 92   |
| G  | 16                | 10                | 6    | 9                 | 8    | 6    | 6                 | 7    | 7    | 6    | 5                 | 6    | 5    | 4    |

| COUNTERWEIGHT 10.0 t (22,000 lbs)<br>ON OUTRIGGERS FULLY EXTENDED 7.3 m (23'11-3/8") SPREAD<br>360° ROTATION |                    |      |      |                    |      |      |                    |      |      |                    |      |      |                    |      |                    |                    |
|--|--------------------|------|------|--------------------|------|------|--------------------|------|------|--------------------|------|------|--------------------|------|--------------------|--------------------|
| A  | 13                 | 2    | 1    | 2                  | 3    | 1    | 5                  | 4    | 1    | 6                  | 7    | 1    | 8                  | 1    | 1                  | 9                  |
| B  | 30                 | 15   | 6    | 16                 | 17   | 7    | 19                 | 18   | 8    | 20                 | 21   | 9    | 22                 | 10   | 11                 | 23                 |
| C  | 32.4 m<br>(106.1') |      |      | 36.4 m<br>(119.5') |      |      | 40.5 m<br>(132.8') |      |      | 44.6 m<br>(146.2') |      |      | 48.6 m<br>(159.6') |      | 52.7 m<br>(172.9') | 56.0 m<br>(183.7') |
| D  |                    |      |      |                    |      |      |                    |      |      |                    |      |      |                    |      |                    |                    |
| 2.50   |                    |      |      |                    |      |      |                    |      |      |                    |      |      |                    |      |                    |                    |
| 3.00   |                    |      |      |                    |      |      |                    |      |      |                    |      |      |                    |      |                    |                    |
| 3.50   |                    |      |      |                    |      |      |                    |      |      |                    |      |      |                    |      |                    |                    |
| 4.00   |                    |      |      |                    |      |      |                    |      |      |                    |      |      |                    |      |                    |                    |
| 4.50   |                    |      |      |                    |      |      |                    |      |      |                    |      |      |                    |      |                    |                    |
| 5.00   |                    |      |      |                    |      |      |                    |      |      |                    |      |      |                    |      |                    |                    |
| 6.00   | 27.4               | 25.5 | 18.8 |                    |      |      |                    |      |      |                    |      |      |                    |      |                    |                    |
| 7.00   | 26.1               | 25.5 | 17.7 | 20.7               | 18.6 | 15.5 |                    |      |      |                    |      |      |                    |      |                    |                    |
| 8.00   | 24.4               | 25.5 | 16.7 | 20.7               | 18.6 | 14.6 | 16.9               | 14.4 | 13.9 |                    |      |      |                    |      |                    |                    |
| 9.00   | 22.8               | 25.5 | 15.7 | 20.1               | 18.6 | 13.8 | 16.9               | 14.4 | 13.3 | 14.4               | 12.4 | 12.0 |                    |      |                    |                    |
| 10.00  | 21.3               | 25.5 | 14.7 | 19.0               | 18.3 | 13.0 | 16.7               | 14.4 | 12.7 | 14.4               | 12.3 | 12.0 | 11.6               | 10.5 |                    |                    |
| 11.00  | 19.7               | 22.1 | 13.8 | 17.8               | 17.6 | 12.2 | 15.9               | 13.8 | 12.1 | 13.8               | 11.8 | 11.7 | 11.6               | 10.5 | 9.4                |                    |
| 12.00  | 17.8               | 19.0 | 13.0 | 16.8               | 16.9 | 11.5 | 15.0               | 13.2 | 11.5 | 13.2               | 11.4 | 11.2 | 11.6               | 10.5 | 9.4                | 8.2                |
| 14.00  | 13.3               | 14.4 | 11.6 | 14.0               | 14.9 | 10.3 | 13.4               | 12.1 | 10.4 | 12.0               | 10.5 | 10.4 | 10.9               | 10.1 | 9.4                | 8.2                |
| 16.00  | 10.3               | 11.3 | 10.4 | 10.9               | 11.8 | 9.2  | 10.9               | 11.1 | 9.5  | 10.9               | 9.6  | 9.5  | 10.0               | 9.5  | 9.1                | 8.2                |
| 18.00  | 8.1                | 9.1  | 9.5  | 8.7                | 9.6  | 8.4  | 8.7                | 9.8  | 8.7  | 8.8                | 8.9  | 8.8  | 9.0                | 8.9  | 8.5                | 7.8                |
| 20.00  | 6.5                | 7.4  | 8.7  | 7.1                | 7.9  | 7.6  | 7.0                | 8.1  | 8.0  | 7.1                | 8.1  | 8.2  | 7.4                | 8.0  | 7.6                | 7.3                |
| 22.00  | 5.2                | 6.1  | 7.4  | 5.7                | 6.6  | 7.0  | 5.7                | 6.8  | 7.1  | 5.8                | 6.8  | 6.9  | 6.0                | 6.7  | 6.3                | 6.3                |
| 24.00  | 4.2                | 5.1  | 6.3  | 4.7                | 5.5  | 6.2  | 4.7                | 5.7  | 6.1  | 4.8                | 5.7  | 5.8  | 5.0                | 5.6  | 5.3                | 5.3                |
| 26.00  | 3.3                | 4.2  | 5.4  | 3.9                | 4.7  | 5.3  | 3.8                | 4.8  | 5.2  | 3.9                | 4.9  | 4.9  | 4.1                | 4.7  | 4.4                | 4.4                |
| 28.00  | 2.6                | 3.5  | 4.7  | 3.1                | 3.9  | 4.6  | 3.1                | 4.1  | 4.5  | 3.2                | 4.1  | 4.2  | 3.4                | 4.0  | 3.7                | 3.7                |
| 30.00  | 2.1                | 3.0  | 4.1  | 2.6                | 3.3  | 4.0  | 2.5                | 3.5  | 3.9  | 2.6                | 3.5  | 3.6  | 2.8                | 3.4  | 3.1                | 3.0                |
| 32.00  |                    |      |      | 2.1                | 2.8  | 3.4  | 2.0                | 3.0  | 3.3  | 2.1                | 3.0  | 3.1  | 2.3                | 2.9  | 2.5                | 2.5                |
| 34.00  |                    |      |      | 1.6                | 2.4  | 3.0  | 1.6                | 2.6  | 2.9  | 1.7                | 2.6  | 2.6  | 1.8                | 2.4  | 2.1                | 2.1                |
| 36.00  |                    |      |      |                    |      |      | 1.2                | 2.2  | 2.5  | 1.3                | 2.2  | 2.2  | 1.5                | 2.0  | 1.7                | 1.7                |
| 38.00  |                    |      |      |                    |      |      | 0.9                | 1.9  | 2.2  | 0.9                | 1.8  | 1.9  | 1.1                | 1.7  | 1.4                | 1.3                |
| 40.00  |                    |      |      |                    |      |      |                    |      |      |                    | 1.5  | 1.6  |                    | 1.4  | 1.1                | 1.0                |
| 42.00  |                    |      |      |                    |      |      |                    |      |      |                    | 1.3  | 1.4  |                    |      |                    |                    |
| 44.00  |                    |      |      |                    |      |      |                    |      |      |                    |      |      |                    |      | 0.9                |                    |
| E  | 16.0               | 17.3 | 16.7 | 15.4               | 15.4 | 15.0 | 14.4               | 13.8 | 13.9 | 12.4               | 12.4 | 12.0 | 11.6               | 10.5 | 9.4                | 8.2                |
| F  | 0                  | 0    | 0    | 0                  | 0    | 0    | 0                  | 0    | 0    | 0                  | 0    | 0    | 30                 | 0    | 35                 | 41                 |
| Telescoping conditions (%)   |                    |      |      |                    |      |      |                    |      |      |                    |      |      |                    |      |                    |                    |
| Tele.1   | 92                 | 46   | 0    | 92                 | 46   | 0    | 92                 | 46   | 0    | 92                 | 46   | 0    | 92                 | 46   | 92                 | 100                |
| Tele.2   | 46                 | 46   | 0    | 46                 | 46   | 0    | 92                 | 46   | 46   | 92                 | 46   | 92   | 92                 | 92   | 92                 | 100                |
| Tele.3   | 46                 | 46   | 46   | 46                 | 46   | 92   | 46                 | 46   | 92   | 92                 | 92   | 92   | 92                 | 92   | 92                 | 100                |
| Tele.4   | 46                 | 46   | 92   | 46                 | 46   | 92   | 46                 | 92   | 92   | 46                 | 92   | 92   | 92                 | 92   | 92                 | 100                |
| Tele.5   | 0                  | 46   | 92   | 46                 | 92   | 92   | 46                 | 92   | 92   | 46                 | 92   | 92   | 46                 | 92   | 92                 | 100                |
| G  | 4                  | 4    | 4    | 4                  | 4    | 4    | 4                  | 4    | 4    | 4                  | 4    | 4    | 4                  | 4    | 4                  | 4                  |

\*Over front with special equipment

- A: Boom block                      C: Boom length (m)                      E: Maximum capacity without boom pin                      G: Number of parts of line
- B: Boom number                      D: Load radius (m)                      F: Minimum boom angle (°) for indicated length (no load)

Note: The lifting capacity data stored in the LOAD MOMENT INDICATOR (AML-C) is based on the standard number of parts of line listed in the chart.





# GR-1200XL RATED LIFTING CAPACITIES (IN METRIC TON)

| COUNTERWEIGHT 10.0 t (22,000 lbs)<br>ON OUTRIGGERS FULLY EXTENDED 7.3 m (23'11-3/8") SPREAD<br>360° ROTATION |   |     |          |     |          |     |    |   |     |          |     |          |     |
|--|---|-----|----------|-----|----------|-----|----|---|-----|----------|-----|----------|-----|
| C  | 56.0-m (183.7') Boom + 10.1-m (33.2') Manual offset jib |     |          |     |          |     | C  | 52.7-m (172.9') Boom + 10.1-m (33.2') Manual offset jib |     |          |     |          |     |
|  | 3.5° Tilt   |     | 25° Tilt |     | 45° Tilt |     |    | 3.5° Tilt   |     | 25° Tilt |     | 45° Tilt |     |
|  | R   | W   | R        | W   | R        | W   |    | R   | W   | R        | W   | R        | W   |
| 81   | 13.9  | 4.5 | 17.4     | 3.9 | 20.5     | 3.6 | 81 | 13.3  | 5.0 | 16.8     | 4.3 | 19.4     | 3.8 |
| 80   | 15.3  | 4.5 | 18.5     | 3.8 | 21.6     | 3.5 | 80 | 14.5  | 5.0 | 17.8     | 4.2 | 20.4     | 3.8 |
| 79   | 16.6  | 4.4 | 19.8     | 3.7 | 22.7     | 3.4 | 79 | 15.6  | 4.9 | 18.8     | 4.1 | 21.4     | 3.7 |
| 78   | 18.0  | 4.3 | 20.9     | 3.6 | 23.7     | 3.3 | 78 | 16.9  | 4.8 | 19.9     | 4.0 | 22.4     | 3.6 |
| 77   | 19.1  | 4.1 | 22.1     | 3.5 | 24.9     | 3.2 | 77 | 17.6  | 4.6 | 21.0     | 3.9 | 23.4     | 3.5 |
| 76   | 20.4  | 4.0 | 23.3     | 3.5 | 26.1     | 3.2 | 76 | 19.1  | 4.5 | 22.1     | 3.8 | 24.4     | 3.4 |
| 75   | 21.7  | 3.9 | 24.5     | 3.4 | 27.1     | 3.1 | 75 | 20.2  | 4.4 | 23.1     | 3.7 | 25.4     | 3.4 |
| 73   | 24.1  | 3.7 | 26.8     | 3.2 | 29.3     | 3.0 | 73 | 22.4  | 4.1 | 25.2     | 3.5 | 27.4     | 3.3 |
| 70   | 27.7  | 3.4 | 30.1     | 3.0 | 32.5     | 2.9 | 70 | 25.6  | 3.8 | 28.5     | 3.3 | 30.4     | 3.1 |
| 68   | 30.0  | 3.2 | 32.4     | 2.9 | 34.5     | 2.8 | 68 | 27.8  | 3.6 | 30.6     | 3.2 | 32.4     | 3.0 |
| 65   | 32.9  | 2.5 | 35.1     | 2.3 | 37.1     | 2.3 | 65 | 30.9  | 3.2 | 33.6     | 2.9 | 35.2     | 2.8 |
| 63   | 34.6  | 2.0 | 36.8     | 1.9 | 38.7     | 1.9 | 63 | 32.7  | 2.7 | 35.2     | 2.4 | 36.6     | 2.4 |
| 60   | 37.1  | 1.5 | 39.3     | 1.5 | 41.0     | 1.5 | 60 | 35.4  | 2.1 | 37.6     | 1.9 | 38.7     | 1.9 |
| 58   | 38.8  | 1.2 | 40.9     | 1.2 | 42.5     | 1.2 | 58 | 36.9  | 1.7 | 39.7     | 1.6 | 40.2     | 1.6 |
| 55   | 41.1  | 0.8 | 43.2     | 0.8 |          |     | 55 | 39.2  | 1.3 | 41.3     | 1.2 | 42.3     | 1.2 |
| 53   |   |     |          |     |          |     | 53 | 40.7  | 1.0 | 42.8     | 1.0 | 43.6     | 1.0 |
| 50   |   |     |          |     |          |     | 50 | 43.0  | 0.7 | 44.9     | 0.7 |          |     |

| COUNTERWEIGHT 10.0 t (22,000 lbs)<br>ON OUTRIGGERS FULLY EXTENDED 7.3 m (23'11-3/8") SPREAD<br>360° ROTATION |   |     |          |     |          |     |    |   |     |          |     |          |     |
|--|---|-----|----------|-----|----------|-----|----|---|-----|----------|-----|----------|-----|
| C  | 48.6-m (159.6') Boom + 10.1-m (33.2') Manual offset jib |     |          |     |          |     | C  | 32.4-m (106.1') Boom + 10.1-m (33.2') Manual offset jib |     |          |     |          |     |
|  | 3.5° Tilt   |     | 25° Tilt |     | 45° Tilt |     |    | 3.5° Tilt   |     | 25° Tilt |     | 45° Tilt |     |
|  | R   | W   | R        | W   | R        | W   |    | R   | W   | R        | W   | R        | W   |
| 81   | 12.2  | 6.0 | 15.7     | 5.2 | 18.2     | 4.5 | 81 | 6.9   | 6.6 | 11.2     | 6.6 | 13.1     | 4.9 |
| 80   | 13.2  | 6.0 | 16.6     | 5.0 | 19.1     | 4.4 | 80 | 7.8   | 6.6 | 11.9     | 6.4 | 13.9     | 4.8 |
| 79   | 14.5  | 6.0 | 17.6     | 4.9 | 20.1     | 4.4 | 79 | 8.5   | 6.6 | 12.7     | 6.3 | 14.6     | 4.8 |
| 78   | 15.5  | 5.9 | 18.6     | 4.8 | 21.0     | 4.3 | 78 | 9.3   | 6.6 | 13.5     | 6.1 | 15.3     | 4.7 |
| 77   | 16.5  | 5.7 | 19.6     | 4.7 | 22.0     | 4.2 | 77 | 10.2  | 6.6 | 14.2     | 6.0 | 15.9     | 4.6 |
| 76   | 17.6  | 5.5 | 20.6     | 4.6 | 22.9     | 4.1 | 76 | 10.9  | 6.6 | 15.0     | 5.8 | 16.6     | 4.6 |
| 75   | 18.6  | 5.4 | 21.6     | 4.5 | 24.0     | 4.1 | 75 | 11.7  | 6.6 | 15.7     | 5.7 | 17.2     | 4.5 |
| 73   | 20.6  | 5.0 | 23.6     | 4.3 | 25.8     | 3.9 | 73 | 13.3  | 6.6 | 17.1     | 5.5 | 18.5     | 4.5 |
| 70   | 23.7  | 4.6 | 26.6     | 4.1 | 28.5     | 3.8 | 70 | 15.5  | 6.6 | 19.2     | 5.3 | 20.3     | 4.4 |
| 68   | 25.7  | 4.4 | 28.5     | 3.9 | 30.3     | 3.7 | 68 | 17.0  | 6.6 | 20.5     | 5.1 | 21.5     | 4.3 |
| 65   | 28.4  | 3.7 | 31.0     | 3.3 | 32.7     | 3.2 | 65 | 19.1  | 6.6 | 22.4     | 4.9 | 23.2     | 4.2 |
| 63   | 30.1  | 3.2 | 32.7     | 2.9 | 34.1     | 2.8 | 63 | 20.4  | 6.6 | 23.6     | 4.8 | 24.4     | 4.2 |
| 60   | 32.7  | 2.5 | 34.9     | 2.3 | 36.1     | 2.2 | 60 | 22.3  | 6.2 | 25.4     | 4.7 | 26.0     | 4.2 |
| 58   | 34.3  | 2.1 | 36.4     | 2.0 | 37.4     | 1.9 | 58 | 23.6  | 6.0 | 26.6     | 4.7 | 27.1     | 4.2 |
| 55   | 36.5  | 1.6 | 38.4     | 1.5 | 39.4     | 1.5 | 55 | 25.4  | 5.7 | 28.2     | 4.6 | 28.6     | 4.1 |
| 53   | 37.9  | 1.4 | 39.8     | 1.3 | 40.7     | 1.3 | 53 | 26.5  | 5.2 | 29.3     | 4.5 | 29.5     | 4.1 |
| 50   | 40.0  | 1.0 | 41.8     | 1.0 | 42.6     | 1.0 | 50 | 28.1  | 4.5 | 30.7     | 4.1 | 30.9     | 4.0 |
| 48   | 41.3  | 0.8 | 43.1     | 0.8 | 43.8     | 0.8 | 48 | 29.1  | 4.1 | 31.6     | 3.8 | 31.7     | 3.7 |
| 45   | 43.3  | 0.6 |          |     |          |     | 45 | 30.6  | 3.7 | 32.9     | 3.4 | 32.9     | 3.3 |
| 43   |   |     |          |     |          |     | 43 | 31.6  | 3.4 | 33.7     | 3.2 |          |     |
| 40   |   |     |          |     |          |     | 40 | 32.9  | 3.0 | 34.8     | 2.9 |          |     |
| 38   |   |     |          |     |          |     | 38 | 33.8  | 2.8 | 35.5     | 2.7 |          |     |
| 35   |   |     |          |     |          |     | 35 | 34.9  | 2.6 | 36.5     | 2.5 |          |     |
| 33   |   |     |          |     |          |     | 33 | 35.7  | 2.4 | 37.1     | 2.3 |          |     |
| 30   |   |     |          |     |          |     | 30 | 36.7  | 2.2 | 37.9     | 2.1 |          |     |
| 25   |   |     |          |     |          |     | 25 | 38.2  | 1.9 | 39.0     | 1.9 |          |     |
| 20   |   |     |          |     |          |     | 20 | 39.4  | 1.7 |          |     |          |     |
| 15   |   |     |          |     |          |     | 15 | 40.3  | 1.6 |          |     |          |     |
| 10   |   |     |          |     |          |     | 10 | 40.9  | 1.5 |          |     |          |     |

C: Loaded boom angle (°)  
R: Load radius in meters  
W: Rated lifting capacity in metric ton

NOTE: The lifting capacity data stored in the LOAD MOMENT INDICATOR (AML-C) is based on the standard number of parts of line listed in the chart.

# GR-1200XL RATED LIFTING CAPACITIES (IN METRIC TON)

| COUNTERWEIGHT 10.0 t (22,000 lbs)<br>ON OUTRIGGERS FULLY EXTENDED 7.3 m (23'11-3/8") SPREAD<br>360° ROTATION |   |     |          |     |          |     |    |   |     |          |     |          |     |
|--|---|-----|----------|-----|----------|-----|----|---|-----|----------|-----|----------|-----|
| C  | 56.0-m (183.7') Boom + 17.7-m (58.1') Manual offset jib |     |          |     |          |     | C  | 52.7-m (172.9') Boom + 17.7-m (58.1') Manual offset jib |     |          |     |          |     |
|  | 3.5° Tilt   |     | 25° Tilt |     | 45° Tilt |     |    | 3.5° Tilt   |     | 25° Tilt |     | 45° Tilt |     |
|  | R   | W   | R        | W   | R        | W   |    | R   | W   | R        | W   | R        | W   |
| 81   | 16.2  | 2.9 | 23.0     | 2.7 | 27.4     | 2.3 | 81 | 15.2  | 3.1 | 21.3     | 2.8 | 26.3     | 2.3 |
| 80   | 17.7  | 2.9 | 24.3     | 2.6 | 28.6     | 2.2 | 80 | 16.5  | 3.1 | 22.9     | 2.8 | 27.3     | 2.3 |
| 79   | 19.3  | 2.9 | 25.6     | 2.5 | 29.9     | 2.2 | 79 | 18.0  | 3.1 | 24.0     | 2.7 | 28.4     | 2.3 |
| 78   | 20.8  | 2.9 | 27.1     | 2.5 | 31.1     | 2.2 | 78 | 19.4  | 3.1 | 25.2     | 2.6 | 29.5     | 2.2 |
| 77   | 22.4  | 2.9 | 28.3     | 2.4 | 32.3     | 2.1 | 77 | 20.8  | 3.1 | 26.5     | 2.6 | 30.6     | 2.2 |
| 76   | 24.0  | 2.9 | 29.7     | 2.4 | 33.4     | 2.1 | 76 | 22.1  | 3.1 | 27.7     | 2.5 | 31.7     | 2.2 |
| 75   | 25.4  | 2.8 | 30.9     | 2.3 | 34.7     | 2.1 | 75 | 23.5  | 3.1 | 28.9     | 2.5 | 32.7     | 2.1 |
| 73   | 28.4  | 2.7 | 33.5     | 2.2 | 36.9     | 2.0 | 73 | 26.2  | 3.0 | 31.3     | 2.4 | 34.8     | 2.1 |
| 70   | 32.4  | 2.5 | 37.3     | 2.1 | 40.1     | 1.9 | 70 | 30.2  | 2.8 | 34.8     | 2.3 | 37.8     | 2.0 |
| 68   | 34.8  | 2.2 | 39.4     | 1.9 | 42.1     | 1.8 | 68 | 32.6  | 2.6 | 37.0     | 2.2 | 40.0     | 2.0 |
| 65   | 37.5  | 1.6 | 42.2     | 1.4 | 44.6     | 1.3 | 65 | 36.0  | 2.2 | 40.1     | 1.9 | 42.6     | 1.7 |
| 63   | 39.2  | 1.2 | 43.9     | 1.1 | 46.2     | 1.1 | 63 | 37.7  | 1.8 | 41.6     | 1.5 | 44.1     | 1.5 |
| 60   | 42.1  | 0.8 |          |     |          |     | 60 | 40.2  | 1.3 | 44.1     | 1.1 | 46.3     | 1.1 |
| 58   |   |     |          |     |          |     | 58 | 41.9  | 1.0 | 45.8     | 0.9 | 47.8     | 0.9 |
| 55   |   |     |          |     |          |     | 55 | 44.6  | 0.7 |          |     |          |     |

| COUNTERWEIGHT 10.0 t (22,000 lbs)<br>ON OUTRIGGERS FULLY EXTENDED 7.3 m (23'11-3/8") SPREAD<br>360° ROTATION |   |     |          |     |          |     |    |   |     |          |     |          |     |
|--|---|-----|----------|-----|----------|-----|----|---|-----|----------|-----|----------|-----|
| C  | 48.6-m (159.6') Boom + 17.7-m (58.1') Manual offset jib |     |          |     |          |     | C  | 32.4-m (106.1') Boom + 17.7-m (58.1') Manual offset jib |     |          |     |          |     |
|  | 3.5° Tilt   |     | 25° Tilt |     | 45° Tilt |     |    | 3.5° Tilt   |     | 25° Tilt |     | 45° Tilt |     |
|  | R   | W   | R        | W   | R        | W   |    | R   | W   | R        | W   | R        | W   |
| 81   | 14.1  | 3.5 | 20.2     | 3.0 | 24.6     | 2.4 | 81 | 9.2   | 4.5 | 15.8     | 3.3 | 19.7     | 2.4 |
| 80   | 15.3  | 3.5 | 21.4     | 3.0 | 25.6     | 2.3 | 80 | 10.2  | 4.5 | 16.7     | 3.2 | 20.5     | 2.3 |
| 79   | 16.7  | 3.5 | 22.5     | 2.9 | 26.7     | 2.3 | 79 | 11.1  | 4.5 | 17.5     | 3.1 | 21.2     | 2.3 |
| 78   | 18.0  | 3.5 | 23.6     | 2.8 | 27.7     | 2.3 | 78 | 12.1  | 4.5 | 18.3     | 3.0 | 22.0     | 2.3 |
| 77   | 19.2  | 3.5 | 24.8     | 2.8 | 28.7     | 2.2 | 77 | 13.1  | 4.5 | 19.1     | 3.0 | 22.7     | 2.2 |
| 76   | 20.5  | 3.5 | 25.9     | 2.7 | 29.7     | 2.2 | 76 | 14.0  | 4.5 | 20.0     | 2.9 | 23.4     | 2.2 |
| 75   | 21.9  | 3.5 | 27.1     | 2.7 | 30.7     | 2.2 | 75 | 14.9  | 4.5 | 20.8     | 2.9 | 24.1     | 2.2 |
| 73   | 24.4  | 3.5 | 29.3     | 2.6 | 32.7     | 2.2 | 73 | 16.7  | 4.5 | 22.4     | 2.8 | 25.5     | 2.2 |
| 70   | 28.0  | 3.3 | 32.5     | 2.4 | 35.5     | 2.1 | 70 | 19.2  | 4.1 | 24.6     | 2.6 | 27.4     | 2.1 |
| 68   | 30.4  | 3.2 | 34.6     | 2.3 | 37.5     | 2.1 | 68 | 20.8  | 3.8 | 26.2     | 2.5 | 28.7     | 2.1 |
| 65   | 33.5  | 2.7 | 37.8     | 2.3 | 40.2     | 2.0 | 65 | 23.2  | 3.6 | 28.3     | 2.4 | 30.5     | 2.0 |
| 63   | 35.4  | 2.3 | 39.5     | 2.0 | 41.6     | 1.8 | 63 | 24.7  | 3.4 | 29.7     | 2.4 | 31.7     | 2.0 |
| 60   | 37.8  | 1.7 | 41.7     | 1.5 | 43.7     | 1.4 | 60 | 27.0  | 3.2 | 31.7     | 2.3 | 33.5     | 2.0 |
| 58   | 39.4  | 1.4 | 43.3     | 1.3 | 45.1     | 1.2 | 58 | 28.5  | 3.2 | 33.0     | 2.3 | 34.5     | 2.0 |
| 55   | 41.8  | 1.0 | 45.5     | 0.9 | 47.0     | 0.9 | 55 | 30.6  | 3.0 | 34.8     | 2.2 | 36.1     | 2.0 |
| 53   | 43.4  | 0.8 | 46.9     | 0.7 |          |     | 53 | 31.9  | 2.9 | 36.0     | 2.2 | 37.0     | 1.9 |
| 50   |   |     |          |     |          |     | 50 | 33.8  | 2.8 | 37.7     | 2.1 | 38.3     | 1.9 |
| 48   |   |     |          |     |          |     | 48 | 35.1  | 2.7 | 38.7     | 2.1 | 39.1     | 1.9 |
| 45   |   |     |          |     |          |     | 45 | 36.9  | 2.6 | 40.2     | 2.1 | 40.3     | 1.9 |
| 43   |   |     |          |     |          |     | 43 | 38.0  | 2.4 | 41.1     | 2.1 |          |     |
| 40   |   |     |          |     |          |     | 40 | 39.5  | 2.2 | 42.3     | 2.0 |          |     |
| 38   |   |     |          |     |          |     | 38 | 40.5  | 2.0 | 43.0     | 1.8 |          |     |
| 35   |   |     |          |     |          |     | 35 | 41.8  | 1.8 | 44.0     | 1.7 |          |     |
| 33   |   |     |          |     |          |     | 33 | 42.7  | 1.7 | 44.6     | 1.6 |          |     |
| 30   |   |     |          |     |          |     | 30 | 43.9  | 1.5 | 45.4     | 1.4 |          |     |
| 25   |   |     |          |     |          |     | 25 | 45.5  | 1.3 | 46.4     | 1.2 |          |     |
| 20   |   |     |          |     |          |     | 20 | 46.9  | 1.2 |          |     |          |     |
| 15   |   |     |          |     |          |     | 15 | 47.8  | 1.0 |          |     |          |     |
| 10   |   |     |          |     |          |     | 10 | 48.4  | 1.0 |          |     |          |     |

C: Loaded boom angle (°)  
R: Load radius in meters  
W: Rated lifting capacity in metric ton

NOTE: The lifting capacity data stored in the LOAD MOMENT INDICATOR (AML-C) is based on the standard number of parts of line listed in the chart.

# GR-1200XL RATED LIFTING CAPACITIES (IN METRIC TON)

| COUNTERWEIGHT 10.0 t (22,000 lbs)<br>ON RUBBER STATIONARY |            |         |        |         |        |         |        |         |        |         |               |         |        |         |        |         |        |         |        |         |     |  |
|---|------------|---------|--------|---------|--------|---------|--------|---------|--------|---------|---------------|---------|--------|---------|--------|---------|--------|---------|--------|---------|-----|--|
| A   | Over front |         |        |         |        |         |        |         |        |         | 360° Rotation |         |        |         |        |         |        |         |        |         |     |  |
|   | 12.0 m     |         | 16.1 m |         | 20.1 m |         | 24.2 m |         | 28.3 m |         | 12.0 m        |         | 16.1 m |         | 20.1 m |         | 24.2 m |         | 28.3 m |         |     |  |
| B   | C          | (39.4') | C      | (52.7') | C      | (66.1') | C      | (79.4') | C      | (92.8') | C             | (39.4') | C      | (52.7') | C      | (66.1') | C      | (79.4') | C      | (92.8') |     |  |
| 4.5   | 63         | 23.2    |        |         |        |         |        |         |        |         |               | 63      | 14.0   |         |        |         |        |         |        |         |     |  |
| 5.0   | 60         | 21.0    |        |         |        |         |        |         |        |         |               | 60      | 12.3   |         |        |         |        |         |        |         |     |  |
| 6.0   | 54         | 17.5    | 65     | 18.6    |        |         |        |         |        |         |               | 54      | 9.5    | 65      | 10.8   |         |        |         |        |         |     |  |
| 7.0   | 47         | 14.8    | 60     | 15.8    |        |         |        |         |        |         |               | 47      | 5.7    | 60      | 8.7    |         |        |         |        |         |     |  |
| 8.0   | 39         | 12.6    | 56     | 13.7    | 64     | 14.2    |        |         |        |         |               | 39      | 4.1    | 56      | 5.4    | 64      | 6.0    |         |        |         |     |  |
| 9.0   | 29         | 10.8    | 51     | 11.9    | 61     | 12.4    | 67     | 12.9    | 71     | 12.9    |               | 29      | 2.9    | 51      | 4.1    | 61      | 4.8    | 67      | 5.3    | 71      | 5.4 |  |
| 10.0  |            |         | 46     | 10.4    | 57     | 10.9    | 64     | 11.4    | 69     | 11.5    |               |         |        | 46      | 3.1    | 57      | 3.7    | 64      | 4.3    | 69      | 4.4 |  |
| 11.0  |            |         | 40     | 9.2     | 54     | 9.7     | 61     | 10.2    | 67     | 10.3    |               |         |        | 40      | 2.3    | 54      | 3.0    | 61      | 3.5    | 67      | 3.6 |  |
| 12.0  |            |         | 34     | 7.0     | 50     | 7.6     | 58     | 9.1     | 64     | 9.2     |               |         |        | 34      | 1.7    | 50      | 2.3    | 58      | 2.8    | 64      | 2.9 |  |
| 14.0  |            |         |        |         | 41     | 5.6     | 52     | 6.2     | 59     | 6.3     |               |         |        |         |        | 41      | 1.3    | 52      | 1.8    | 59      | 1.9 |  |
| 16.0  |            |         |        |         | 30     | 4.2     | 46     | 4.8     | 54     | 4.9     |               |         |        |         |        |         |        | 46      | 1.1    | 54      | 1.2 |  |
| 18.0  |            |         |        |         |        |         | 38     | 3.7     | 49     | 3.8     |               |         |        |         |        |         |        |         |        |         |     |  |
| 20.0  |            |         |        |         |        |         | 28     | 2.9     | 43     | 3.0     |               |         |        |         |        |         |        |         |        |         |     |  |
| 22.0  |            |         |        |         |        |         | 12     | 2.3     | 36     | 2.3     |               |         |        |         |        |         |        |         |        |         |     |  |
| 24.0  |            |         |        |         |        |         |        |         | 27     | 1.8     |               |         |        |         |        |         |        |         |        |         |     |  |
| 26.0  |            |         |        |         |        |         |        |         | 12     | 1.4     |               |         |        |         |        |         |        |         |        |         |     |  |
| D   | 0          |         |        |         |        |         |        |         |        |         | 0             |         | 27     |         | 37     |         | 48     |         |        |         |     |  |
| Telescoping conditions (%)                                |            |         |        |         |        |         |        |         |        |         |               |         |        |         |        |         |        |         |        |         |     |  |
| Tele.1  | 0          | 0       | 0      | 0       | 0      | 0       | 0      | 0       | 0      | 0       | 0             | 0       | 0      | 0       | 0      | 0       | 0      | 0       | 0      | 0       | 0   |  |
| Tele.2  | 0          | 0       | 0      | 0       | 0      | 0       | 0      | 0       | 0      | 0       | 0             | 0       | 0      | 0       | 0      | 0       | 0      | 0       | 0      | 0       | 0   |  |
| Tele.3  | 0          | 0       | 0      | 0       | 0      | 0       | 0      | 0       | 0      | 0       | 0             | 0       | 0      | 0       | 0      | 0       | 0      | 0       | 0      | 0       | 0   |  |
| Tele.4  | 0          | 0       | 0      | 0       | 0      | 46      | 92     | 92      | 92     | 92      | 0             | 0       | 0      | 46      | 92     | 92      | 92     | 92      | 92     | 92      | 92  |  |
| Tele.5  | 0          | 46      | 92     | 92      | 92     | 92      | 92     | 92      | 92     | 92      | 0             | 46      | 92     | 92      | 92     | 92      | 92     | 92      | 92     | 92      | 92  |  |
| E   | 4          | 4       | 4      | 4       | 4      | 4       | 4      | 4       | 4      | 4       | 4             | 4       | 4      | 4       | 4      | 4       | 4      | 4       | 4      | 4       | 4   |  |

- A: Boom length in meters
- B: Load radius in meters
- C: Loaded boom angle (°)
- D: Minimum boom angle (°) for indicated length (no load)
- E: Number of parts of line

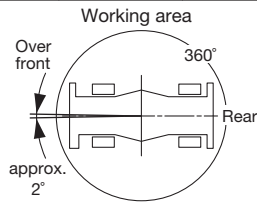

NOTE: The lifting capacity data stored in the LOAD MOMENT INDICATOR (AML-C) is based on the standard number of parts of line listed in the chart. Standard number of parts of line for on-rubber operation should be according to the chart.

| COUNTERWEIGHT 10.0 t (22,000 lbs)<br>ON-RUBBER CREEP |            |         |        |         |        |         |        |         |        |         |  |  |  |
|--|------------|---------|--------|---------|--------|---------|--------|---------|--------|---------|--|--|--|
| A  | Over front |         |        |         |        |         |        |         |        |         |  |  |  |
|  | 12.0 m     |         | 16.1 m |         | 20.1 m |         | 24.2 m |         | 28.3 m |         |  |  |  |
| B  | C          | (39.4') | C      | (52.7') | C      | (66.1') | C      | (79.4') | C      | (92.8') |  |  |  |
| 4.5  | 63         | 17.1    |        |         |        |         |        |         |        |         |  |  |  |
| 5.0  | 60         | 15.3    |        |         |        |         |        |         |        |         |  |  |  |
| 6.0  | 54         | 12.5    | 65     | 13.6    |        |         |        |         |        |         |  |  |  |
| 7.0  | 47         | 10.3    | 60     | 11.4    |        |         |        |         |        |         |  |  |  |
| 8.0  | 39         | 8.6     | 56     | 9.7     | 64     | 10.2    |        |         |        |         |  |  |  |
| 9.0  | 29         | 7.2     | 51     | 8.3     | 61     | 8.8     | 67     | 9.3     | 71     | 9.4     |  |  |  |
| 10.0   |            |         | 46     | 7.1     | 57     | 7.7     | 64     | 8.2     | 69     | 8.3     |  |  |  |
| 11.0   |            |         | 40     | 6.1     | 54     | 6.7     | 61     | 7.2     | 67     | 7.3     |  |  |  |
| 12.0   |            |         | 34     | 5.3     | 50     | 5.8     | 58     | 6.4     | 64     | 6.4     |  |  |  |
| 14.0   |            |         |        |         | 41     | 4.5     | 52     | 5.0     | 59     | 5.1     |  |  |  |
| 16.0   |            |         |        |         | 30     | 3.4     | 46     | 3.9     | 54     | 4.0     |  |  |  |
| 18.0   |            |         |        |         |        |         | 38     | 3.1     | 49     | 3.2     |  |  |  |
| 20.0   |            |         |        |         |        |         | 28     | 2.4     | 43     | 2.5     |  |  |  |
| 22.0   |            |         |        |         |        |         | 12     | 1.9     | 36     | 1.9     |  |  |  |
| 24.0   |            |         |        |         |        |         |        |         | 27     | 1.5     |  |  |  |
| 26.0   |            |         |        |         |        |         |        |         | 12     | 1.1     |  |  |  |
| D  | 0          |         |        |         |        |         |        |         |        |         |  |  |  |
| Telescoping conditions (%)                           |            |         |        |         |        |         |        |         |        |         |  |  |  |
| Tele.1   | 0          | 0       | 0      | 0       | 0      | 0       | 0      | 0       | 0      | 0       |  |  |  |
| Tele.2   | 0          | 0       | 0      | 0       | 0      | 0       | 0      | 0       | 0      | 0       |  |  |  |
| Tele.3   | 0          | 0       | 0      | 0       | 0      | 0       | 0      | 0       | 0      | 0       |  |  |  |
| Tele.4   | 0          | 0       | 0      | 0       | 0      | 46      | 92     | 92      | 92     | 92      |  |  |  |
| Tele.5   | 0          | 46      | 92     | 92      | 92     | 92      | 92     | 92      | 92     | 92      |  |  |  |
| E  | 4          | 4       | 4      | 4       | 4      | 4       | 4      | 4       | 4      | 4       |  |  |  |

- A: Boom length in meters
- B: Load radius in meters
- C: Loaded boom angle (°)
- D: Minimum boom angle (°) for indicated length (no load)
- E: Number of parts of line

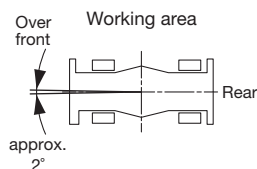

NOTE: The lifting capacity data stored in the LOAD MOMENT INDICATOR (AML-C) is based on the standard number of parts of line listed in the chart. Standard number of parts of line for on-rubber operation should be according to the chart.

# WARNING AND OPERATING INSTRUCTIONS FOR ON RUBBER LIFTING CAPACITIES

## NOTES FOR ON-RUBBER LIFTING CAPACITIES

1. Rated lifting capacities on-rubber are in pounds and do not exceed 75% of tipping loads as determined by SAE J765-Crane Stability Test Code.
2. Rated lifting capacities shown in The chart are based on condition that crane is set on firm level surfaces with suspension-lock applied. Those above thick lines are based on tire capacity and those below, on crane stability. They are based on actual load radius increased by tire deformation and boom deflection.
3. If the suspension-lock cylinders contain air, The axle will not be locked completely and rated lifting capacities may not be obtainable. Bleed the cylinders according to the operation safety and maintenance manual.
4. Rated lifting capacities are based on proper tire inflation, capacity and condition. Damaged tires are hazardous to safe operation of crane.
5. Tires shall be inflated to correct air pressure.
 

| Tires        | Air Pressure      |
|--------------|-------------------|
| 29.5-25 34PR | 400 kPa (57 psi.) |
6. Over front operation shall be performed within 2 degrees in front of chassis.
7. On-rubber lifting with "jib" is not permitted. Maximum permissible boom length is 28.3 m (92.8').
8. When making lift on-rubber stationary, set parking brake.
9. For creep operation, boom must be centered over front of machine, slewing lock engaged, and load restrained from slewing. Travel slowly and keep the lifted load as close to the ground as possible, and especially avoid any abrupt steering, accelerating or braking.
10. Do not operate the crane while carrying the load.
11. Creep is motion for crane not to travel more than 60 m (200 ft.) in any 30 minute period and to travel at the speed of less than 1.6 km/h (1 mph).
12. For creep operation, choose the drive mode and proper gear according to the road or working condition.
13. The mass of the hook (1080 kg (2380 lbs) for 110 metric ton (120 ton) capacity, 680 kg (1,500 lbs) for 70 metric ton (77 ton) capacity, 610 kg (1,340 lbs) for 45 metric ton (50 ton) capacity, 300 kg (660 lbs) for 7.2 metric ton (7.9 ton) capacity), slings and all similarly used load handling devices must be considered as part of the load and must be deducted from the lifting capacities.
15. For rated lifting capacity of single top, reduce the rated lifting capacities of relevant boom according to a weight reductions for auxiliary load handling equipment. Capacities of single top shall not exceed 7,200 kg (15,900 lbs) including main hook.
16. The lifting capacity data stowed in the LOAD MOMENT INDICATOR (AML-C) is based on the standard number of parts of line listed in the chart. Standard number of parts of line for on rubber operation should be according to the following table.

# WARNING AND OPERATING INSTRUCTIONS

## NOTES FOR LIFTING CAPACITIES

### GENERAL

1. RATED LIFTING CAPACITIES apply only to the machine as originally manufactured and normally equipped by TADANO LTD. Modifications to the machine or use of optional equipment other than that specified can result in a reduction of capacity.
2. Hydraulic cranes can be hazardous if improperly operated or maintained. Operation and maintenance of this machine must be in compliance with information, in the Operation and Maintenance Manual supplied with the crane. If this manual is missing, order a replacement through the distributor.
3. The operator and other personnel associated with this machine shall fully acquaint themselves with the latest American National Standards Institute (ANSI) safety standards for cranes.

### SET UP

1. Rated lifting capacities on the chart are the maximum allowable crane capacities and are based on the machine standing level on firm supporting surface under ideal job conditions. Depending on the nature of the supporting surface, it may be necessary to have structural supports under the outrigger floats or tires to spread the loads to a larger bearing surface.
2. For outrigger operation, outriggers shall be properly extended with tires free of supporting surface before operating crane.

### OPERATION

1. Rated lifting capacities have been tested to and meet minimum requirements of SAE J1063-Cantilevered Boom Crane Structures Method of Test.
2. Rated lifting capacities do not exceed 85% of the tipping load on outriggers fully extended as determined by SAE J765-Crane Stability Test Code.  
Rated lifting capacities FOR partially extended outriggers are determined from the formula, Rated Lifting Capacities=(Tipping Load-0.1×Tip Reaction)/1.25.
3. Rated lifting capacities above thick lines in the chart are based on crane strength and those below, on its stability. They are based on actual load radius increased by boom deflection.
4. The weight of handling device such as hook blocks, slings, etc., must be considered as part of the load and must be deducted from the lifting capacities.
5. Rated lifting capacities are based on freely suspended loads and make no allowance for such factors as the effect of wind, sudden stopping of loads, supporting surface conditions, inflation of tires, operating speeds, side loads, etc. Side pull on the boom or jib is extremely dangerous.  
Such action can damage the boom, jib or swing mechanism, and lead to overturning of the crane.
6. Rated lifting capacities do not account for wind on lifted load or boom. We recommend against working under the condition that the load is out of control due to a strong wind. During boom lift, consider that the rated lifting capacity is reduced by 50% when the wind speed is 9 m/s (20 mph) to 12 m/s (27 mph); reduced by 70% when the wind speed is 12 m/s (27 mph) to 14 m/s (31 mph). If the wind speed is 14 m/s (31 mph) or over, stop operation. However, in the following conditions, stop operation at wind speed of 12 m/s (27 mph): Boom length is 56.0 m (183.7') (all 100%), and boom angle is 55° or less. Boom length is 52.7 m (172.9') (all 92%), and boom angle is 45° or less.  
During jib lift, stop operation if the wind speed is 9 m/s (20 mph) or over.

7. Rated lifting capacities at load radius shall not be exceeded. Do not tip the crane to determine allowable loads.
8. Do not operate at boom lengths, radii, or boom angle, where no capacities are shown. Crane may overturn without any load on the hook.
9. When boom length is between values listed, refer to the rated lifting capacities of the next longer and next shorter booms for the same radius. the lesser of the two rated lifting capacities shall be used.
10. When making lifts at a load radius not shown, use the next longer radius to determine allowable capacity.
11. Load per line should not exceed 7,200 kg (15,900 lbs.) for main winch and auxiliary winch.
12. Check the actual number of parts of line with LOAD MOMENT INDICATOR (AML-C) before operation. Maximum lifting capacity is restricted by the number of parts of line of LOAD MOMENT INDICATOR (AML-C). Limited capacity is as determined FROM the formula, Single line pull for main winch 7,200 kg (15,900 lbs.) x number of parts of line.
13. The boom angle before loading should be greater to account for deflection. For rated lifting capacities, the loaded boom angle and the load radius is for reference only.
14. Maximum capacity without boom pin is shown in the chart.
15. Do not operate extension or retraction of the boom with loads.
16. For lifting capacity of single top, deduct the weight of the load handling equipment from the rated lifting capacity of the boom. For the lifting capacity of single top, the net capacity shall not exceed 7,200 kg (15,900 lbs.) including main boom hook mass attached to the boom.
17. When the base jib or top jib or both jibs are removed, set the jib status switch to the DISMOUNTED position.
18. When erecting and stowing jib, be sure to retain it by hand or by other means to prevent its free movement.
19. Use "ANTI-TWO-BLOCK" disable switch when erecting and stowing jib and when stowing hook block.  
While the switch is pushed, the hoist does not stop, even when overwind condition occurs.
20. For selected boom length or less with jib, rated lifting capacities are determined by loaded boom angle only in the column headed "selected boom + jib".
21. Crane operation is prohibited without full counterweight 10 metric ton (22,000 lbs.) installed. Outriggers shall be extended 7.3 m (23'11 3/8") spread when installing or removing removable counterweight.

### DEFINITIONS

1. Load Radius: Horizontal distance from a projection of the axis of rotation to supporting surface before loading to the center of the vertical hoist line or tackle with load applied.
2. Loaded boom angle: THE angle between the boom base section and the horizontal, after lifting the rated lifting capacity at the load radius.
3. Working Area: Area measured in a circular arc about the centerline of rotation.
4. Freely suspended Load: Load hanging free with no direct external force applied except by the hoist line.
5. Side Load: Horizontal side force applied to the lifted load either on the ground or in the air.

## NOTES FOR LOAD MOMENT INDICATOR (AML-C)

1. Set AML select keys in accordance with the actually operating crane conditions and don't fail to make sure, before crane operation, that the displays on front panel are correct.
2. When operating crane on outriggers:
  - Set "P.T.O." switch to "ON".
  - Press the outrigger state select key to register for the outrigger operation. If the display agrees with the actual state, press the set key to register. After the completion of the registration, the pop-up window closes.
  - Press the lift state select key to register the lift state to be used (single top/jib/boom).
  - Each time the lift state select key is pressed, the display changes. If the display agrees with the actual state, press the set key to register. After the completion of the registration, the pop-up window closes.
  - When erecting and stowing jib, select the status of jib set (Jib lift indicator symbol flickers).
3. When operating crane on-rubber:
  - Set "P.T.O." switch to "ON".
  - Press the outrigger state select key to register for the on-rubber operation. Each time the outrigger state select key is pressed, the display changes. Select the creep operation, the on-rubber state indicator symbol flickers.
  - Press the lift state select key to register the lift state.

However, pay attention to the following.

  - (1) For stationary operation.
    - The front capacities are attainable only when the over front position symbol comes on. When the boom is more than 2 degrees from centered over front of chassis, 360° capacities are in effect.
    - When a load is lifted in the front position and then slewed to the side area, make sure the value of the LOAD MOMENT INDICATOR (AML-C) is below the 360° lifting capacity.
  - (2) For creep operation.
    - The creep capacities are attainable only when boom is in the straight forward position of chassis and the over front position symbol is on. If boom is not in the straight forward position of chassis, never lift load.
4. This machine is equipped with an automatic swing stopping device. (For the details, see Operation and Maintenance Manual.) But, operate very carefully because the automatic swing stop does not work in the following cases.
  - During on-rubber operation.
  - When the "P.T.O." switch is set to "OVERRIDE" and the "OVERRIDE" key switch outside the cab is on.
5. During crane operation, make sure that the displays on front panel are in accordance with actual operating conditions.
6. THE displayed values of LOAD MOMENT INDICATOR (AML-C) are based on freely suspended loads and make no allowance FOR such factors as the effect of wind, sudden stopping of loads, supporting surface conditions, inflation of tire, operating speed, side loads, etc.  
For safe operation, it is recommended when extending and lowering boom or swinging, lifting loads shall be appropriately reduced.
7. LOAD MOMENT INDICATOR (AML-C) is intended as an aid to the operator. Under no condition should it be relied upon to replace use of capacity charts and operating instruction. Sole reliance upon LOAD MOMENT INDICATOR (AML-C) aids in place of good operating practice can cause an accident. The operator must exercise caution to assure safety.
8. The lifting capacity differs depending on the outrigger extension width and slewing position. Work with the capacity corresponding to the outrigger extension width and slewing position. For the relationship among the outrigger extension width, slewing position and lifting capacities, refer to the working area charts.

## GR-1200XL Axle weight distribution chart

|  | Kilograms |        |         | Pounds  |        |         |
|--|-----------|--------|---------|---------|--------|---------|
|  | GVW       | Front  | Rear    | GVW     | Front  | Rear    |
| Basic machine                          | 55,590    | 27,740 | 27,850  | 122,554 | 61,156 | 61,398  |
| Remove:                                |           |        |         |         |        |         |
| 1. 7.2 metric ton (7.9 ton) hook block | -300      | -457   | 157     | -661    | -1,007 | 346     |
| 2. 110 metric ton (120 ton) hook block | -1,080    | -2,085 | 1,005   | -2,381  | -4,596 | 2,215   |
| 3. Top jib                             | -334      | -448   | 114     | -736    | -989   | 252     |
| 4. Base jib                            | -857      | -1,697 | 840     | -1,889  | -3,741 | 1,852   |
| 5. Auxiliary lifting sheave            | -59       | -175   | 116     | -129    | -385   | 256     |
| 6. Counterweight                       | -10,000   | 4,367  | -14,367 | -22,046 | 9,628  | -31,674 |
| 7. Auxiliary winch & wire rope         | -1,031    | 464    | -1,494  | -2,272  | 1,022  | -3,295  |
| Add:                                   |           |        |         |         |        |         |
| 1. 70 metric ton (77 ton) hook block   | 680       | 1,313  | -633    | 1,500   | 2,896  | -1,396  |
| 2. 45 metric ton (50 ton) hook block   | 610       | 1,178  | -568    | 1,336   | 2,579  | -1,243  |





**TADANO**

**TADANO LTD.** (International Sales Division)

4-12, Kamezawa 2-chome,  
Sumida-ku, Tokyo 130-0014, Japan

Tel: +81-(0)3-3621-7750

Fax: +81-(0)3-3621-7785

<http://www.tadano.com/>

[info@tadano.com](mailto:info@tadano.com)

Printed in Japan  
2018-08-1